

S60 SERIES

The **S60** series, standard 50x50x15 mm compact housing, offers all the most advanced optic functions, as well as the universal, available with safety class 1 laser emission. The series presents a complete range of models, including retroreflex with coaxial optics and polarisation filters for the detection of shiny and/or transparent objects, background suppression, contrast sensors with white light emission for the detection of coloured marks, the sensor with UV emission for the detection of luminescence references and the distance sensor with analogue output. The basic models for presence detection present trimmer sensitivity adjustment, while the models with the advanced optics are microprocessor controlled and have the patent-covered EASYtouch™ setting, which gives rapid and precise setting of the switching threshold, with the possibility of remote control, keyboard block and selection of the output delay function. The **S60** series offers versions with cable or M12 connection that can be rotated for either straight or right-angle positions. All versions have NPN or PNP output and standard configuration conforming to the EN 60947-5-2 standard.

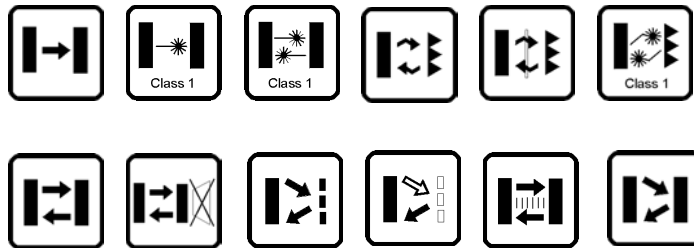

HIGHLIGHTS

- Complete range of optic functions, basic, advanced and laser class 1
- Models with coaxial optics for polarised retroreflex, contrast and luminescence sensors
- Trimmer or EASYtouch™ setting with Remote, Keylock and Delay functions
- Standard cable or M12 connection with standard NPN or PNP configuration

APPLICATIONS

Ceramics

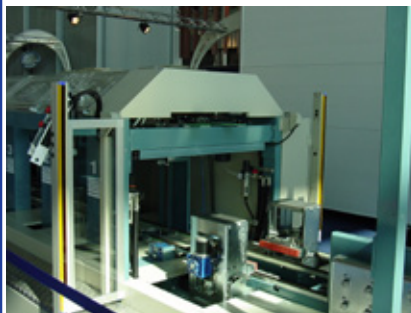

Transportation lines



Beverage & Bottling



Packaging lines



G/F INFRARED EMISSION

The detection system with two separate emitter and receiver units allows the user to reach larger operating distances. The trimmer, present on the receiver, allows to adjust sensitivity and to detect objects that obscure, even partially, the light emission. The IR emission is modulated to avoid interference with other light sources and can be turned off to test the functioning even without the object to detect.



DIMENSIONS

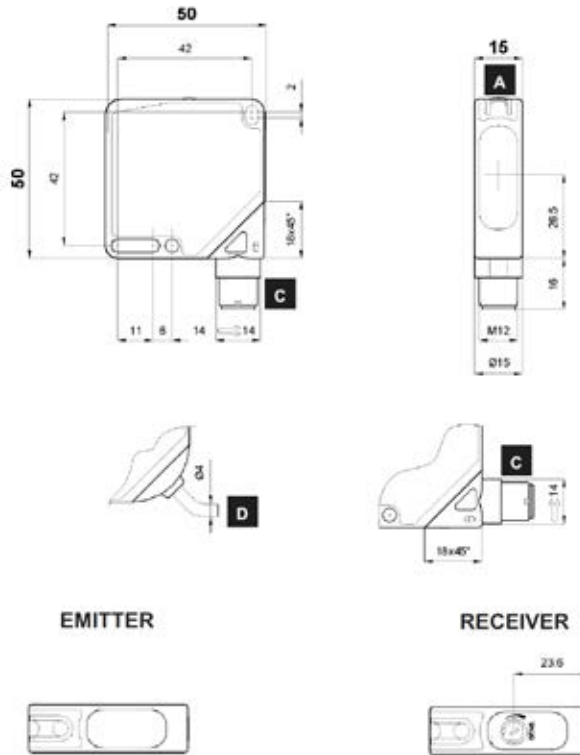

EMITTER

RECEIVER

INDICATORS AND SETTINGS

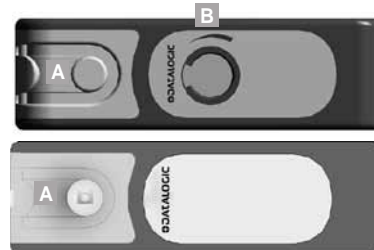

- A** Output status and stability LEDs (receiver); power on LED (emitter)
- B** Adjustment trimmer (receiver)
- C** M12 connector output
- D** Cable output

Single-turn trimmer for sensitivity adjustment. Rotate clockwise to increase the operating distance.

ACCESSORIES

For **dedicated accessories** refer to the **ACCESSORIES** section of this catalogue.

Refer also to **Connectors and Fixing brackets** of the **General Catalogue**.

CONNECTIONS



S60-PA-2

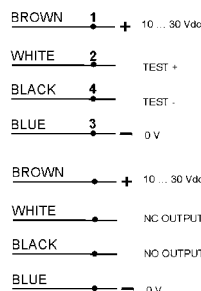

S60-PA-5

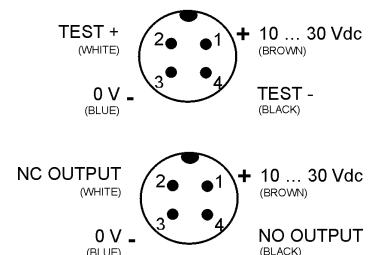

EMITTER

RECEIVER

TECHNICAL DATA

TECHNICAL NOTES

- ¹Limit values
- ²Average life of 100.000 h with TA = +25 °C
- ³270° trimmer
- ⁴Emitter off with Test+ on Vdc and Test- on 0 V
- ⁵PVC, 4 x 0.14 mm²
- ⁶Connector can be blocked on two positions
- ⁷A - reverse polarity protection
- ⁸Internal lenses in Polycarbonate

		S60-PA-2-F01-NN	S60-PA-2-F01-PP	S60-PA-2-G00-XG	S60-PA-5-F01-NN	S60-PA-5-F01-PP	S60-PA-5-G00-XG
Operating distance:	0 ... 20 m	•	•	•	•	•	•
Power supply:	10 ... 30 Vdc ¹	•	•	•	•	•	•
Ripple:	≤ 2 Vpp	•	•	•	•	•	•
Consumption:	≤ 35 mA	•	•	•	•	•	•
Light emission:	infrared LED 880 nm ²			•			•
Spot dimension:	aprox. 200 mm at 4 m			•			•
Setting:	sensitivity trimmer ³	•	•		•	•	
Indicators:	yellow OUTPUT LED	•	•		•	•	
	green STABILITY LED	•	•		•	•	
	green POWER ON LED			•			•
Output type:	PNP, NO and NC		•			•	
	NPN, NO and NC	•			•		
Output current:	≤100 mA	•	•		•	•	
Saturation voltage:	≤2 V	•	•		•	•	
Response time:	1 ms	•	•		•	•	
Switching frequency:	500 Hz	•	•		•	•	
Operating mode:	dark on NO / light on NC	•	•		•	•	
Auxiliary functions:	Test + and Test - ⁴			•			•
Connection:	2 m Ø 4 mm cable ⁵	•	•	•			
	M12 4-pole connector ⁶				•	•	•
Electrical protection:	class 2	•	•	•	•	•	•
Mechanical protection:	IP67	•	•	•	•	•	•
Protection devices:	A, B ⁷	•	•	•	•	•	•
Housing material:	ABS	•	•	•	•	•	•
Lens material:	window in PMMA ⁸	•	•	•	•	•	•
Weight:	90 g max.	•	•	•			
	40 g max.				•	•	•
Operating temperature:	-25 ... +55°C	•	•	•	•	•	•
Storage temperature:	-25 ... +70°C	•	•	•	•	•	•
Reference standard:	EN 60947-5-2	•	•	•	•	•	•

SELECTION TABLE

receiver - 2 m cable		
S60-PA-2-F01-NN	956201490	NPN
S60-PA-2-F01-PP	956201330	PNP

emitter - 2 m cable		
S60-PA-2-G00-XG	956201340	

receiver - M12 connector		
S60-PA-5-F01-NN	956201210	NPN
S60-PA-5-F01-PP	956201060	PNP

emitter - M12 connector		
S60-PA-5-G00-XG	956201070	

All the ordering codes and information are summarised in the last pages of this catalogue.



DETECTION DIAGRAMS

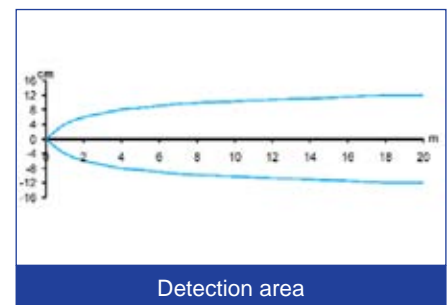
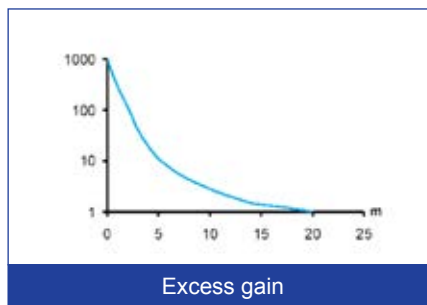
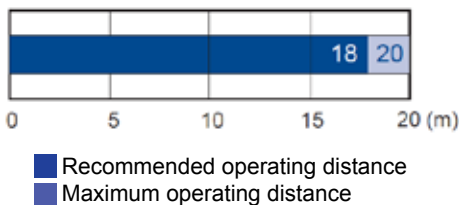

L-G/F RED EMISSION

The high operating distance, typical of the emitter and receiver system, is notably increased thanks to the use of visible red laser emission. The laser beam can be easily aligned and offers excellent detection resolution of even small objects. The class 1 laser emission, according to EN 60825-1, guarantees maximum safety for the operators in all applications.



DIMENSIONS

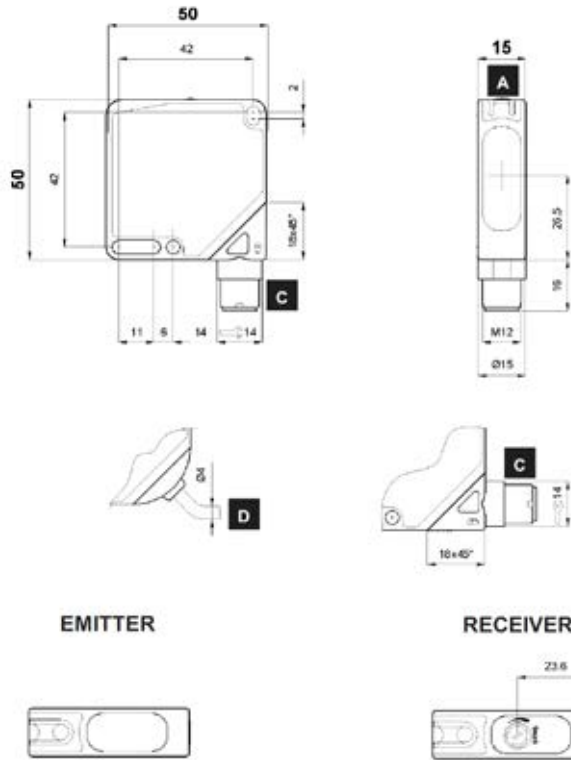

EMITTER

RECEIVER

INDICATORS AND SETTINGS

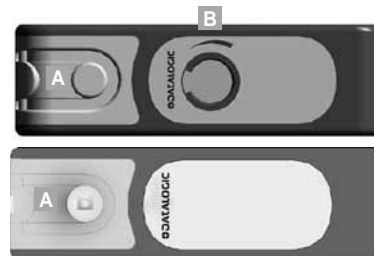

- A** Output status and stability LEDs (receiver); power on LED (emitter)
- B** Adjustment trimmer (receiver)
- C** M12 connector output
- D** Cable output

Single-turn trimmer for sensitivity adjustment. Rotate clockwise direction to increase the operating distance. Decrease sensitivity to increase resolution.

ACCESSORIES

For **dedicated accessories** refer to the **ACCESSORIES** section of this catalogue.

Refer also to **Connectors and Fixing brackets of the General Catalogue**.

CONNECTIONS



S60-PA-2

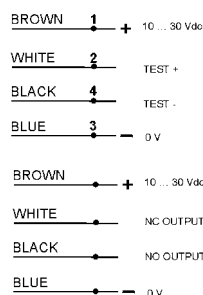

EMITTER



S60-PA-5

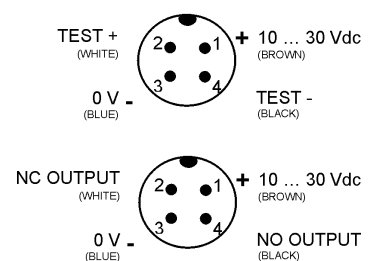

RECEIVER

TECHNICAL DATA

TECHNICAL NOTES

- ¹Limit values
- ²Average life of 100.000 h with TA = +25 °C
- ³270° trimmer
- ⁴Emitter off with Test+ connected to +Vdc
Emitter on with Test+ not connected or connected to 0V
- ⁵PVC, 4 x 0.14 mm²
- ⁶Connector can be blocked on two positions
- ⁷A - reverse polarity protection
- ⁸B - overload and short-circuit protection on receiver outputs
- ⁹Internal lenses in glass and Polycarbonate

		S60-PL-2-F01-NN	S60-PL-2-F01-PP	S60-PL-2-G00-XG	S60-PL-5-F01-NN	S60-PL-5-F01-PP	S60-PL-5-G00-XG
Operating distance:	0 ... 60 m	•	•	•	•	•	•
Power supply:	10 ... 30 Vdc ¹	•	•	•	•	•	•
Ripple:	≤ 2 Vpp	•	•	•	•	•	•
Consumption:	≤ 35 mA	•	•	•	•	•	•
Light emission:	red Laser 650 nm ² class 1 EN 60825-1			•			•
	class II CDRH21 CFR 1040.10						
Resolution:	aprox. 6 mm a 0.5 m aprox.10 mm over 2 m	•	•		•	•	
Setting:	sensitivity trimmer ³	•	•		•	•	
Indicators:	yellow OUTPUT LED green POWER ON LED	•	•		•	•	
Output type:	PNP, NA and NC NPN, NA and NC		•		•		•
Output current:	≤ 100 mA	•	•		•	•	
Saturation voltage:	≤2 V	•	•		•	•	
Response time:	333 μs	•	•		•	•	
Switching frequency:	1.5 kHz	•	•		•	•	
Operating mode:	dark on NO / light on NC	•	•		•	•	
Auxiliary functions:	Test + ⁴			•			•
Connection:	2 m Ø 4 mm cable ⁵ M12 4-pole connector ⁶	•	•	•			•
Electrical protection:	class 2	•	•	•	•	•	•
Mechanical protection:	IP67	•	•	•	•	•	•
Protection devices:	A, B ⁷	•	•	•	•	•	•
Housing material:	ABS	•	•	•	•	•	•
Lens material:	window in PMMA ⁸	•	•	•	•	•	•
Weight:	90 g max. 40 g max.	•	•	•			•
Operating temperature:	-10 ... +50°C	•	•	•	•	•	•
Storage temperature:	-25 ... +70°C	•	•	•	•	•	•
Reference standard:	EN 60947-5-2, EN 60825-1, CDRH21 CFR 1040.10	•	•	•	•	•	•

SELECTION TABLE

receiver - 2 m cable		
S60-PL-2-F01-NN	956201570	NPN
S60-PL-2-F01-PP	956201420	PNP

emitter - 2 m cable		
S60-PL-2-G00-XG	956201430	

receiver - M12 connector		
S60-PL-5-F01-NN	956201270	NPN
S60-PL-5-F01-PP	956201140	PNP

emitter - M12 connector		
S60-PL-5-G00-XG	956201150	

All the ordering codes and information are summarised in the last pages of this catalogue.



DETECTION DIAGRAMS

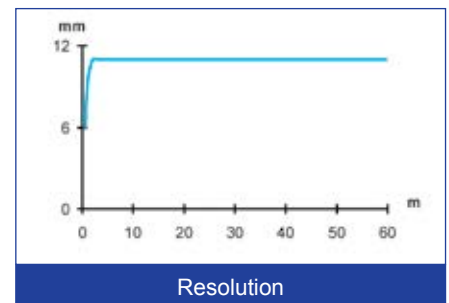
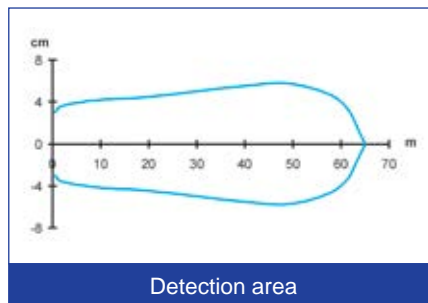
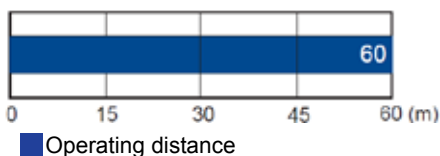

B RED EMISSION

With retroreflex sensors the object is detected when it interrupts the light beam generated between the sensor and its associated prismatic reflector. High-polarisation optic filters also allow reliable detection of very reflective objects, such as mirrored surfaces that, differently from the prismatic reflector, reflect the light beam without rotating the polarisation plane.



DIMENSIONS

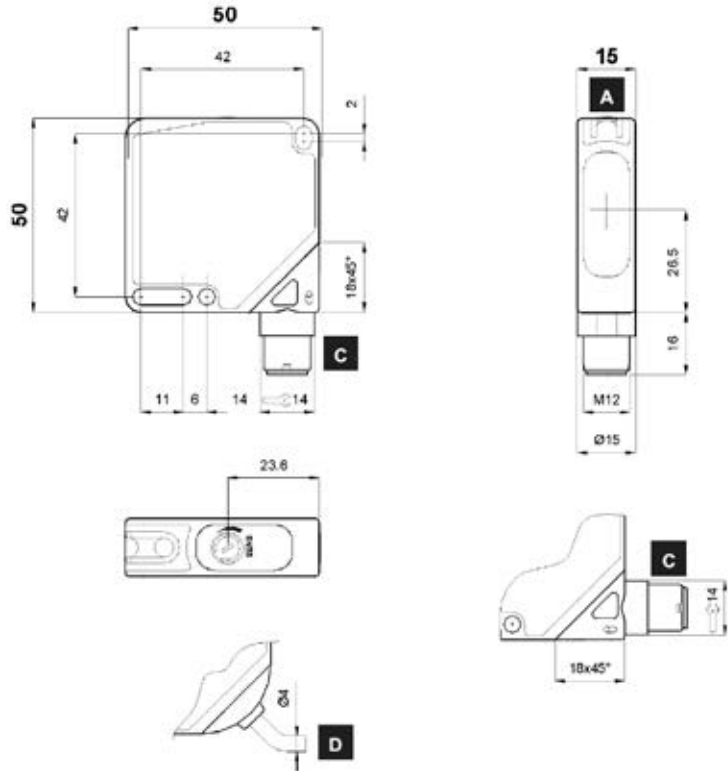

INDICATORS AND SETTINGS

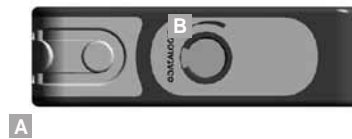

- A** Output status and stability LEDs
- B** Adjustment trimmer
- C** M12 connector output
- D** Cable output

Single-turn trimmer for sensitivity adjustment.
Rotate clockwise to increase the operating distance.

ACCESSORIES

For **dedicated accessories** refer to the **ACCESSORIES** section of this catalogue.

Refer also to **Reflectors (A.01)**, **Connectors (A.03)** and **Fixing Brackets (A.04)** of the **General Catalogue**

CONNECTIONS



S60-PA-2



S60-PA-5

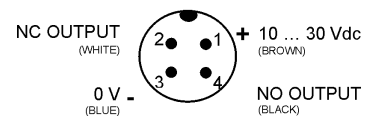
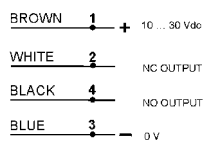

TECHNICAL DATA

TECHNICAL NOTES

¹Limit values

²Average life of 100.000 h with TA = +25 °C

³270° trimmer

⁴PVC, 4 x 0.14 mm²

⁵ Connector can be blocked on two positions

⁶A - reverse polarity protection

B - overload and short-circuit protection on outputs

⁷Internal lenses in Polycarbonate

		S60-PA-2-B01-NN	S60-PA-2-B01-PP	S60-PA-5-B01-NN	S60-PA-5-B01-PP
Operating distance:	0.1 ... 8 m (on R5)	•	•	•	•
Power supply:	10 ... 30 Vdc ¹	•	•	•	•
Ripple:	≤ 2 Vpp	•	•	•	•
Consumption:	≤ 40 mA	•	•	•	•
Light emission:	red LED 660 nm ²	•	•	•	•
Spot dimension:	aprox. 90 mm at 3 m	•	•	•	•
Setting:	sensitivity trimmer ³	•	•	•	•
Indicators:	yellow OUTPUT LED	•	•	•	•
	green STABILITY LED	•	•	•	•
Output type:	PNP, NO and NC	•	•	•	•
	NPN, NO and NC	•	•	•	•
Output current:	≤ 100 mA	•	•	•	•
Saturation voltage:	≤ 2 V	•	•	•	•
Response time:	500 μs	•	•	•	•
Switching frequency:	1 kHz	•	•	•	•
Operating mode:	dark on NO / light on NC	•	•	•	•
Connection:	2 m Ø 4 mm cable ⁴	•	•	•	•
	M12 4-pole connector ⁵	•	•	•	•
Electrical protection:	class 2	•	•	•	•
Mechanical protection:	IP67	•	•	•	•
Protection devices:	A, B ⁶	•	•	•	•
Housing material:	ABS	•	•	•	•
Lens material:	window in PMMA ⁷	•	•	•	•
Weight:	90 g max.	•	•	•	•
	40 g max.	•	•	•	•
Operating temperature:	-25 ... +55°C	•	•	•	•
Storage temperature:	-25 ... +70°C	•	•	•	•
Reference standard:	EN 60947-5-2	•	•	•	•

SELECTION TABLE

axial optics - 2 m cable		
S60-PA-2-B01-NN	956201460	NPN
S60-PA-2-B01-PP	956201300	PNP

axial optics - M12 connector		
S60-PA-5-B01-NN	956201180	NPN
S60-PA-5-B01-PP	956201040	PNP

All the ordering codes and information are summarised in the last pages of this catalogue.



DETECTION DIAGRAMS

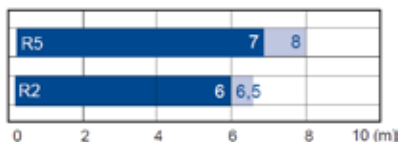

- Recommended operating distance
- Maximum operating distance

High efficiency reflectors can be used to obtain larger operating distances. Refer to **Reflectors (A.01)** of the **General Catalogue**.

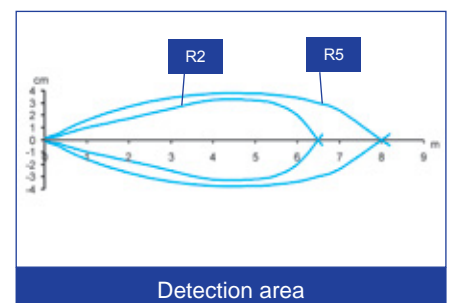
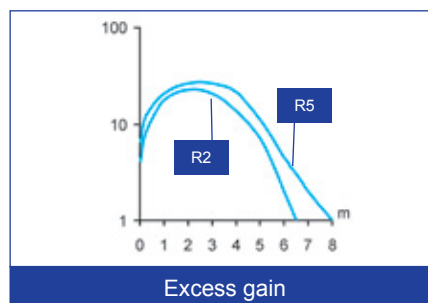

L-B RED EMISSION

The visible red laser emission increases the operating distance and resolution of the polarised retroreflex sensor. Specific R7 or R8 reflectors with 0.8 mm micro-prisms are available for high-resolution detection of small objects. The class 1 laser emission, according to EN 60825-1, guarantees maximum safety for the operators in all applications.



DIMENSIONS

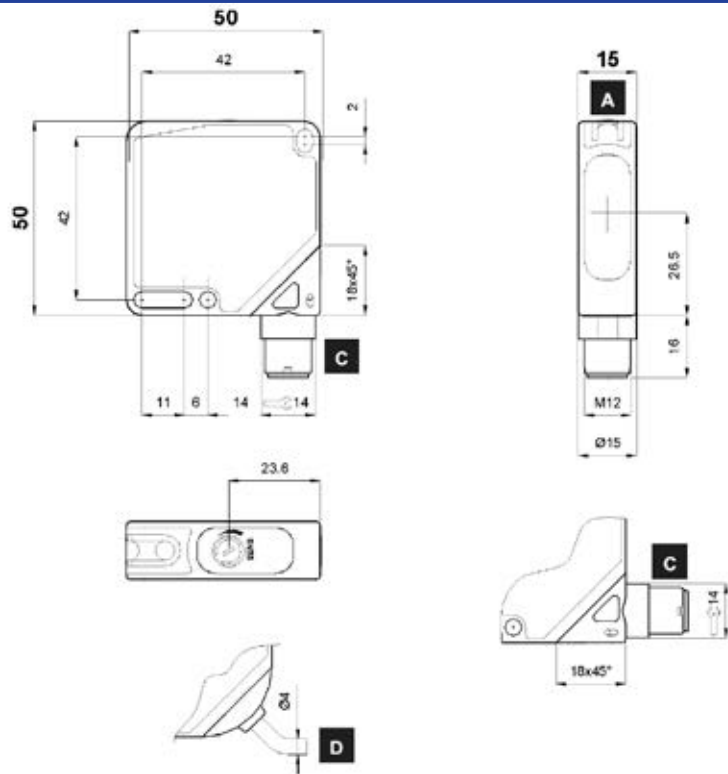

INDICATORS AND SETTINGS

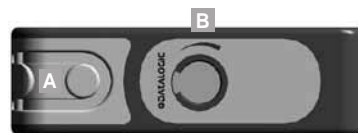

- A** Output status and stability LEDs
- B** Adjustment trimmer
- C** M12 connector output
- D** Cable output

Single-turn trimmer for sensitivity adjustment. Rotate in a clockwise direction to increase the operating distance. Decrease sensitivity to increase resolution.

ACCESSORIES

For **dedicated accessories** refer to the **ACCESSORIES** section of this catalogue.

Refer also to **Connectors and Fixing brackets** of the **General Catalogue**.

CONNECTIONS



S60-PA-2

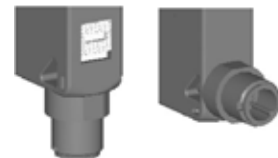

S60-PA-5

BROWN	1	+	10 ... 30 Vdc
WHITE	2		NC OUTPUT
BLACK	4		NO OUTPUT
BLUE	3	-	0 V

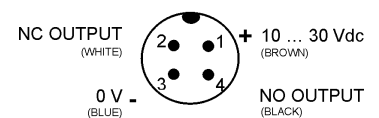

TECHNICAL DATA

TECHNICAL NOTES

- ¹Limit values
- ²Average life of 100.000 h with TA = +25 °C
- ³270° trimmer
- ⁴PVC, 4 x 0.14 mm²
- ⁵Connector can be blocked on two positions
- ⁶A - reverse polarity protection
- ⁷B - overload and short-circuit protection on outputs
- ⁷Internal lenses in glass and Polycarbonate

		S60-PL-2-B01-NN	S60-PL-2-B01-PP	S60-PL-5-B01-NN	S60-PL-5-B01-PP
Operating distance:	0.1 ... 20 m	•	•	•	•
Power supply:	10 ... 30 Vdc ¹	•	•	•	•
Ripple:	≤ 2 Vpp	•	•	•	•
Consumption:	≤ 35 mA	•	•	•	•
Light emission:	red Laser 650 nm ²	•	•	•	•
	class 1 EN 60825-1	•	•	•	•
	class II CDRH21 CFR 1040.10	•	•	•	•
Resolution:	approx. 10 mm	•	•	•	•
Setting:	sensitivity trimmer ³	•	•	•	•
Indicators:	yellow OUTPUT LED	•	•	•	•
	green POWER ON LED	•	•	•	•
Output type:	PNP, NO and NC		•		•
	NPN, NO and NC	•		•	
Output current:	≤ 100 mA	•	•	•	•
Saturation voltage:	≤ 2 V	•	•	•	•
Response time:	250 ms	•	•	•	•
Switching frequency:	2 kHz	•	•	•	•
Operating mode:	dark on NO / light on NC	•	•	•	•
Connection:	2 m Ø 4 mm cable ⁴	•	•		
	M12 4-pole connector ⁵			•	•
Electrical protection:	class 2	•	•	•	•
Mechanical protection:	IP67	•	•	•	•
Protection devices:	A, B ⁶	•	•	•	•
Housing material:	ABS	•	•	•	•
Lens material:	window in PMMA	•	•	•	•
Weight:	90 g max.	•	•		
	40 g max.			•	•
Operating temperature:	-10 ... +50°C	•	•	•	•
Storage temperature:	-25 ... +70°C	•	•	•	•
Standard reference:	EN 60947-5-2, EN 60825-1,	•	•	•	•
	CDRH21 CFR 1040.10	•	•	•	•

SELECTION TABLE

axial optics - 2 m cable		
S60-PL-2-B01-NN	956201560	NPN
S60-PL-2-B01-PP	956201410	PNP

axial optics - M12 connector		
S60-PL-5-B01-NN	956201260	NPN
S60-PL-5-B01-PP	956201120	PNP

All the ordering codes and information are summarised in the last pages of this catalogue.



DETECTION DIAGRAMS



■ Operating distance

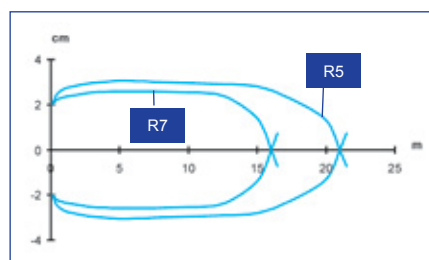

Detection area

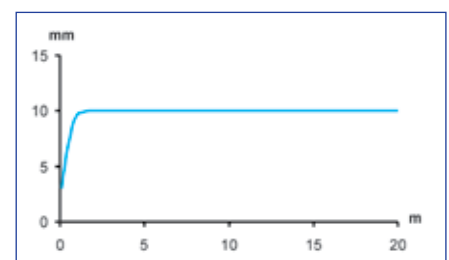

Resolution on R7 reflector

High efficiency reflectors can be used to obtain larger operating distances. Refer to **Reflectors (A.01)** of the **General Catalogue**.

B RED EMISSION

The polarised retroreflex sensor with a coaxial optics offers the best resolution of the detection point as the optic emitting axis coincides with the optic receiving axis. The coaxial system also allows to reduce drastically the sensor's blind zone and consents the detection of objects very close to the sensor's frontal lens.



DIMENSIONS

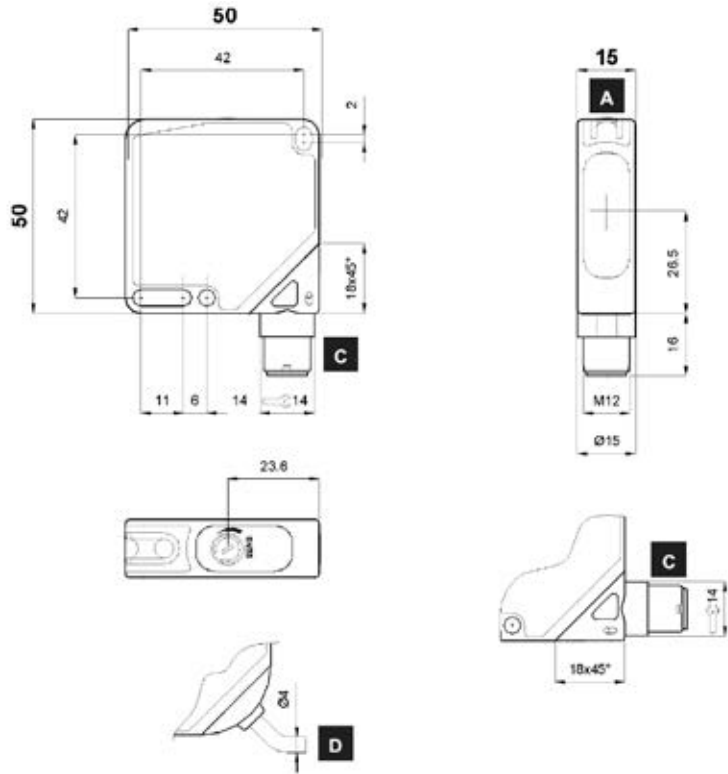

INDICATORS AND SETTINGS

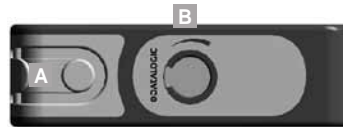

- A** Output status and stability LEDs
- B** Adjustment trimmer
- C** M12 connector output
- D** Cable output

Single-turn trimmer for sensitivity adjustment. Rotate in a clockwise direction to increase the operating distance.

ACCESSORIES

For **dedicated accessories** refer to the **ACCESSORIES** section of this catalogue.

Refer also to **Connectors and Fixing brackets of the General Catalogue**.

CONNECTIONS

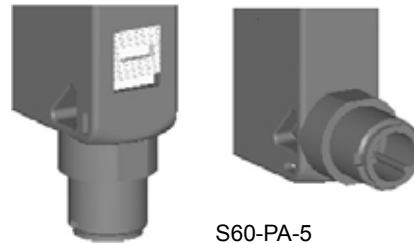

S60-PA-5

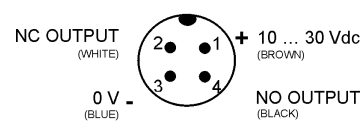

TECHNICAL DATA

TECHNICAL NOTES

- ¹Limit values
- ²Average life of 100.000 h with TA = +25 °C
- ³270° trimmer
- ⁴PVC, 4 x 0.14 mm²
- ⁵Connector can be blocked on two positions
- ⁶A - reverse polarity protection
B - overload and short-circuit protection on outputs
- ⁷Internal lenses in Polycarbonate

		S60-PA-2-B51-NN	S60-PA-2-B51-PP	S60-PA-5-B51-NN	S60-PA-5-B51-PP
Operating distance:	0 ... 4 m	•	•	•	•
Power supply:	10 ... 30 Vdc ¹	•	•	•	•
Ripple:	≤ 2 Vpp	•	•	•	•
Consumption:	≤ 40 mA	•	•	•	•
Light emission:	red LED 660 nm ²	•	•	•	•
Spot dimension:	aprox. 50 mm at 1.5 m	•	•	•	•
Setting:	sensitivity trimmer ³	•	•	•	•
Indicators:	yellow OUTPUT LED	•	•	•	•
	green STABILITY LED	•	•	•	•
Output type:	PNP, NO and NC	•	•	•	•
	NPN, NO and NC	•	•	•	•
Output current:	≤ 100 mA		•		•
Saturation voltage:	≤ 2 V	•		•	
Response time:	500 μs	•	•	•	•
Switching frequency:	1 kHz	•	•	•	•
Operating mode:	dark on NO / light on NC	•	•	•	•
Connection:	2 m Ø 4 mm cable ⁴	•	•	•	•
	M12 4-pole connector ⁵	•	•	•	•
Electrical protection:	class 2	•	•		
Mechanical protection:	IP67			•	•
Protection devices:	A, B ⁶	•	•	•	•
Housing material:	ABS	•	•	•	•
Lens material:	window in glass (tilted anti-reflection) ⁷	•	•	•	•
Weight:	90 g max.	•	•	•	•
	40 g max.	•	•	•	•
Operating temperature:	-25 ... +55°C	•	•	•	•
Storage temperature:	-25 ... +70°C			•	•
Reference standard:	EN 60947-5-2	•	•	•	•

SELECTION TABLE

coaxial optics - M12 connector		
S60-PA-5-B51-NN	956201630	NPN
S60-PA-5-B51-PP	956201620	PNP

All the ordering codes and information are summarised in the last pages of this catalogue.



DETECTION DIAGRAMS

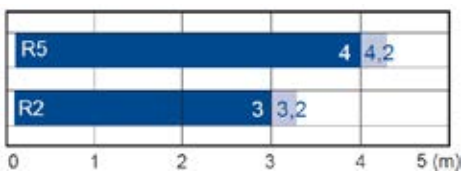

- Recommended operating distance
- Maximum operating distance

High efficiency reflectors can be used to obtain larger operating distances. Refer to **Reflectors (A.01)** of the **General Catalogue**.

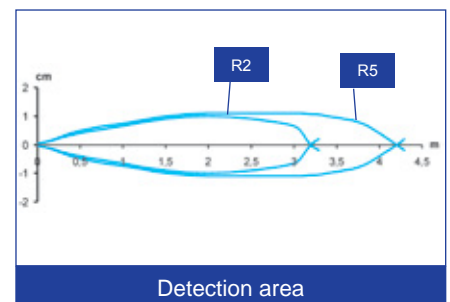
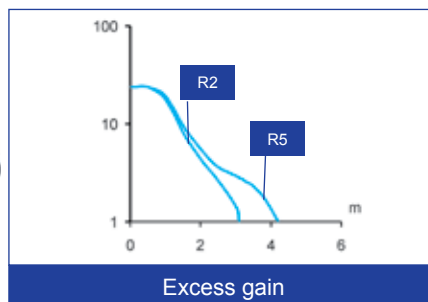

T RETROREFLEX

The high sensitivity and reduced hysteresis of this retroreflex sensor allow to detect even the slightest attenuation of the received light emission, caused by the presence of transparent objects, such as glass or PET bottles or plastic film sheets for packaging. The presence of polarisation filters avoids false switching on shiny surfaces and the coaxial optics improves the detection precision on the entire operating range.



DIMENSIONS

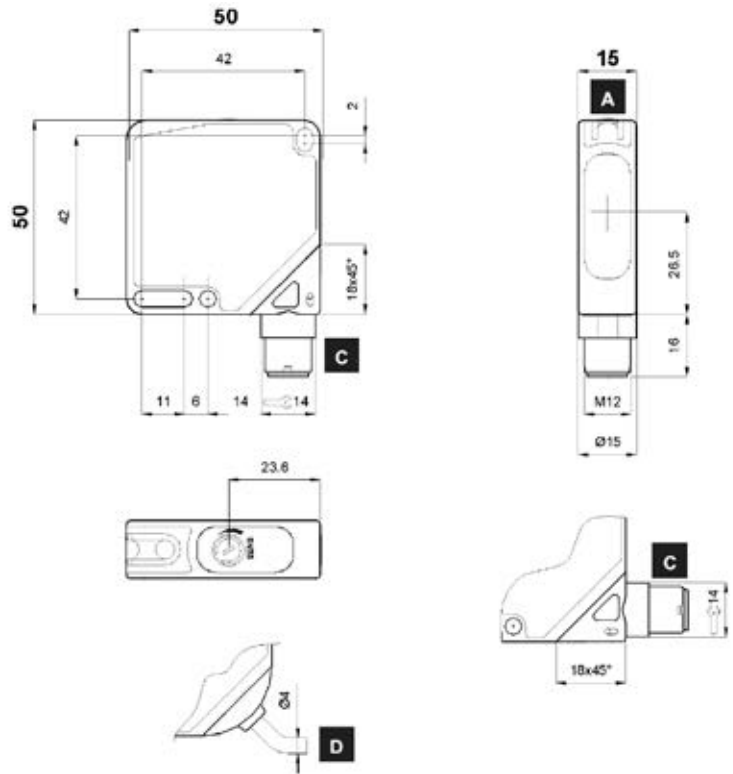

INDICATORS AND SETTINGS

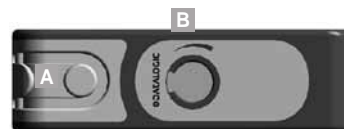

- A** Output status LED
- B** Adjustment trimmer
- C** M12 connector output
- D** Cable output

Single-turn trimmer for sensitivity adjustment. Rotate clockwise direction to increase the operating distance.

ACCESSORIES

For **dedicated accessories** refer to the **ACCESSORIES** section of this catalogue.

Refer also to **Connectors and Fixing brackets** of the **General Catalogue**.

CONNECTIONS



S60-PA-2

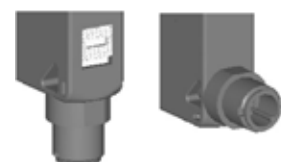

S60-PA-5

BROWN	1	+	10 ... 30 Vdc
WHITE	2		NC OUTPUT
BLACK	4		NO OUTPUT
BLUE	3	-	0 V

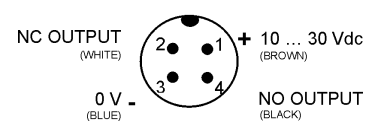

TECHNICAL DATA

TECHNICAL NOTES

- ¹Limit values
- ²Average life of 100.000 h with TA = +25 °C
- ³270° trimmer
- ⁴PVC, 4 x 0,14 mm²
- ⁵Connector can be blocked on two positions
- ⁶A - reverse polarity protection
B - overload and short-circuit protection on outputs
- ⁷Internal lenses in Polycarbonate

		S60-PA-2-T51-NN	S60-PA-2-T51-PP	S60-PA-5-T51-NN	S60-PA-5-T51-PP
Operating distance:	0 ... 2 m	•	•	•	•
Power supply:	10 ... 30 Vdc ¹	•	•	•	•
Ripple:	≤ 2 Vpp	•	•	•	•
Consumption:	≤ 40 mA	•	•	•	•
Light emission:	red LED 660 nm ²	•	•	•	•
Spot dimension:	aprox. 50 mm at 1.5 m	•	•	•	•
Setting:	sensitivity trimmer ³	•	•	•	•
Indicators:	yellow OUTPUT LED	•	•	•	•
Output type:	PNP, NO and NC	•	•	•	•
	NPN, NO and NC	•	•	•	•
Output current:	≤ 100 mA	•	•	•	•
Saturation voltage:	≤ 2 V	•	•	•	•
Response time:	500 μs	•	•	•	•
Switching frequency:	1 kHz	•	•	•	•
Operating mode:	dark on NO / light on NC	•	•	•	•
Connection:	2 m Ø 4 mm cable ⁴	•	•		
	M12 4-pole connector ⁵			•	•
Electrical protection:	class 2	•	•	•	•
Mechanical protection:	IP67	•	•	•	•
Protection devices:	A, B ⁶	•	•	•	•
Housing material:	ABS	•	•	•	•
Lens materiale:	window in glass (tilted anti-reflection) ⁷	•	•	•	•
Weight:	90 g max.	•	•		
	40 g max.			•	•
Operating temperature:	-25 ... +55°C	•	•	•	•
Storage temperature:	-25 ... +70°C	•	•	•	•
Reference standard:	EN 60947-5-2	•	•	•	•

SELECTION TABLE

coaxial optics - 2 m cable		
S60-PA-2-T51-NN	956201530	NPN
S60-PA-2-T51-PP	956201380	PNP

coaxial optics - M12 connector		
S60-PA-5-T51-NN	956201250	NPN
S60-PA-5-T51-PP	956201100	PNP

All the ordering codes and information are summarised in the last pages of this catalogue.



DETECTION DIAGRAMS

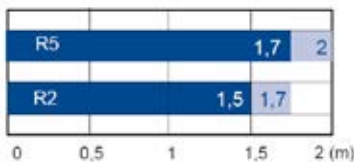

- Recommended operating distance
- Maximum operating distance

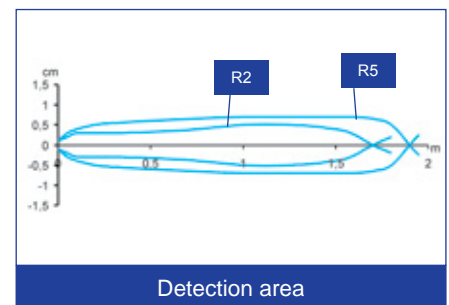
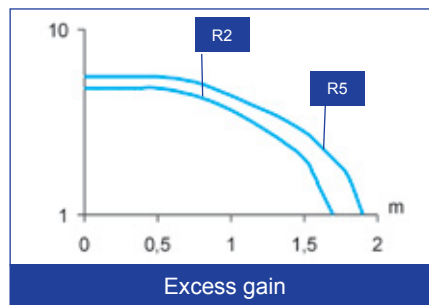

C DIFFUSE PROXIMITY

This diffuse proximity sensor represents a reliable, simple and cost-effective solution for the direct detection of any object within the operating distance, that can be set using the sensitivity adjustment trimmer. The visible red emission facilitates the alignment of the sensor or of the object to detect and in particular in short operating distances.



DIMENSIONS

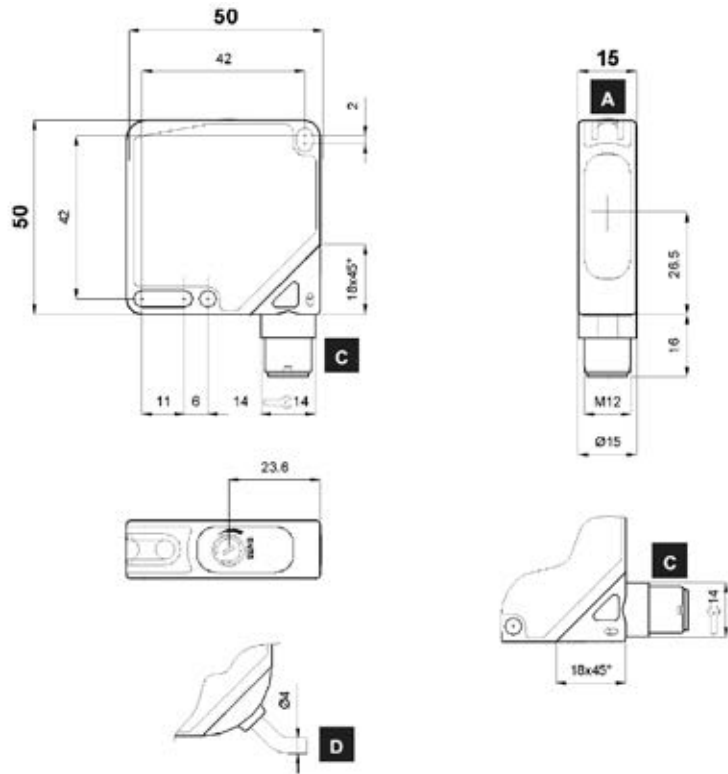

INDICATORS AND SETTINGS

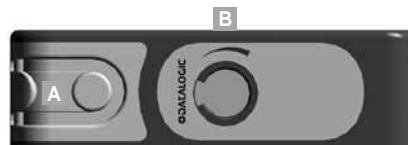

- A** Output status LED
- B** Adjustment trimmer
- C** M12 connector output
- D** Cable output

Single-turn trimmer for sensitivity adjustment. Rotate clockwise direction to increase the operating distance.

ACCESSORIES

For **dedicated accessories** refer to the **ACCESSORIES** section of this catalogue.

Refer also to **Connectors and Fixing brackets** of the **General Catalogue**.

CONNECTIONS



S60-PA-2

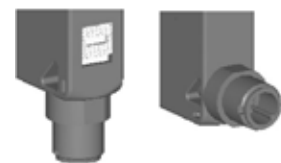

S60-PA-5

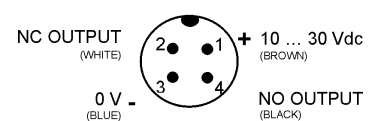
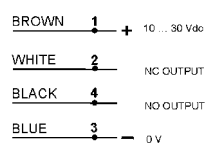

TECHNICAL DATA

TECHNICAL NOTES

- ¹Limit values
- ²Average life of 100.000 h with TA = +25 °C
- ³270° trimmer
- ⁴PVC, 4 x 0.14 mm²
- ⁵Connector can be blocked on two positions
- ⁶A - reverse polarity protection
- ⁷B - overload and short-circuit protection on outputs
- ⁷Internal lenses in Polycarbonate

		S60-PA-2-C01-NN	S60-PA-2-C01-PP	S60-PA-5-C01-NN	S60-PA-5-C01-PP
Operating distance:	0 ... 100 cm	•	•	•	•
Power supply:	10 ... 30 Vdc ¹	•	•	•	•
Ripple:	≤ 2 Vpp	•	•	•	•
Consumption:	≤40 mA	•	•	•	•
Light emission:	red LED 660 nm ²	•	•	•	•
Spot dimension:	approx. 50 mm at 90 cm	•	•	•	•
Setting:	sensitivity trimmer ³	•	•	•	•
Indicators:	yellow OUTPUT LED	•	•	•	•
	green STABILITY LED	•	•	•	•
Output type:	PNP, NO and NC		•		•
	NPN, NO and NC	•		•	
Output current:	≤100 mA	•	•	•	•
Saturation voltage:	≤ 2 V	•	•	•	•
Response time:	1 ms	•	•	•	•
Switching frequency:	500 Hz	•	•	•	•
Operating mode:	light on NO / dark on NC	•	•	•	•
Connection:	2 m Ø 4 mm cable ⁴	•	•		
	M12 4-pole connector ⁵			•	•
Electrical protection:	class 2	•	•	•	•
Mechanical protection:	IP67	•	•	•	•
Protection devices:	A, B ⁶	•	•	•	•
Housing material:	ABS	•	•	•	•
Lens material:	window in PMMA ⁷	•	•	•	•
Weight:	90 g max.	•	•		
	40 g max.			•	•
Operating temperature:	-25 ... +55°C	•	•	•	•
Storage temperature:	-25 ... +70°C	•	•	•	•
Reference standard:	EN 60947-5-2	•	•	•	•

SELECTION TABLE

axial optics - 2 m cable		
S60-PA-2-C01-NN	956201470	NPN
S60-PA-2-C01-PP	956201310	PNP

axial optics - M12 connector		
S60-PA-5-C01-NN	956201190	NPN
S60-PA-5-C01-PP	956201050	PNP

All the ordering codes and information are summarised in the last pages of this catalogue.



DETECTION DIAGRAMS

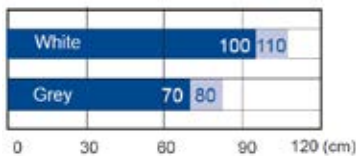

 Recommended operating distance
 Maximum operating distance

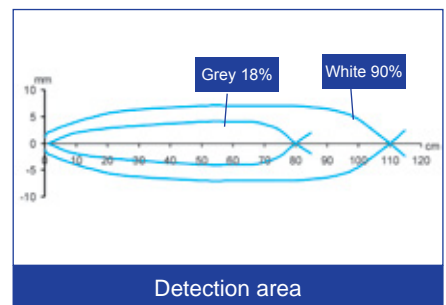
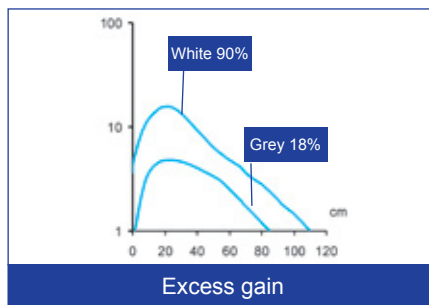

C LONG DIFFUSE PROXIMITY

This version of diffuse proximity sensor offers the maximum operating distance for the direct detection of objects, without the use of separate reflectors or receivers. The detection distance can be set using the sensitivity adjustment trimmer. The green stability LED indicates that the received signal is higher than the minimum signal for stable output switching.



DIMENSIONS

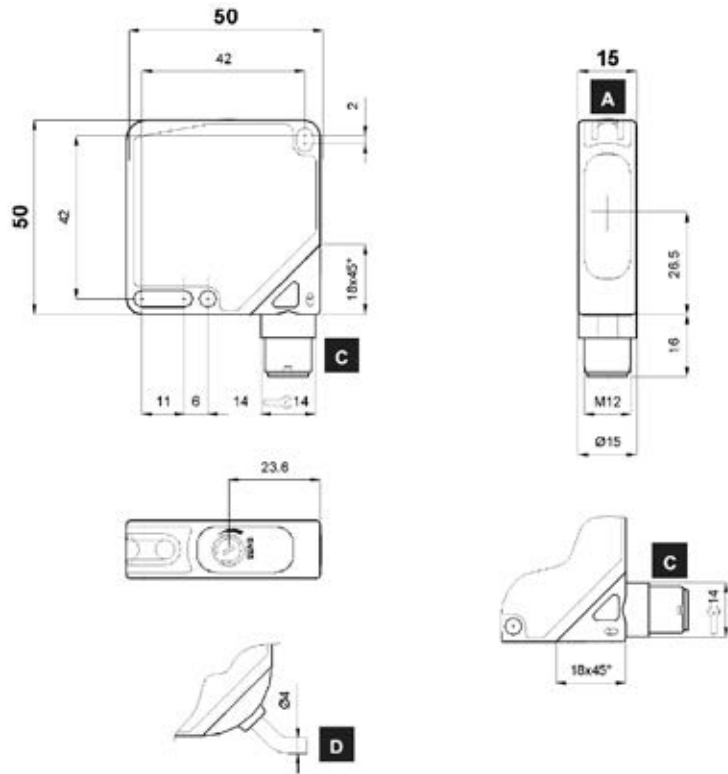

INDICATORS AND SETTINGS

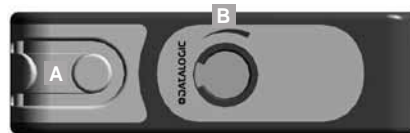

- A** Output status and stability LED
- B** Adjustment trimmer
- C** M12 connector output
- D** Cable output

Single-turn trimmer for sensitivity adjustment. Rotate clockwise direction to increase the operating distance.

ACCESSORIES

For **dedicated accessories** refer to the **ACCESSORIES** section of this catalogue.

Refer also to **Connectors and Fixing brackets** of the **General Catalogue**.

CONNECTIONS



S60-PA-2

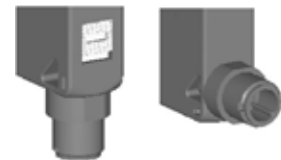

S60-PA-5

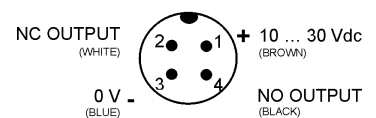
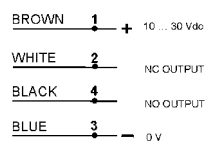

TECHNICAL DATA

TECHNICAL NOTES

- ¹Limit values
- ²Average life of 100.000 h with TA = +25 °C
- ³270° trimmer
- ⁴PVC, 4 x 0.14 mm²
- ⁵Connector can be blocked on two positions
- ⁶A - reverse polarity protection
- ⁷B - overload and short-circuit protection on outputs
- ⁷Internal lenses in Polycarbonate

		S60-PA-2-C01-NN	S60-PA-2-C01-PP	S60-PA-5-C01-NN	S60-PA-5-C01-PP
Operating distance:	5 ... 200 cm	•	•	•	•
Power supply:	10 ... 30 Vdc ¹	•	•	•	•
Ripple:	≤2 Vpp	•	•	•	•
Consumption:	≤ 40 mA	•	•	•	•
Light emission:	infrared LED 880 nm ²	•	•	•	•
Spot dimension:	approx. 250 mm at 1 m	•	•	•	•
Setting:	sensitivity trimmer ³	•	•	•	•
Indicators:	yellow OUTPUT LED	•	•	•	•
	green STABILITY LED	•	•	•	•
Output type:	PNP, NO and NC		•		•
	NPN, NO and NC	•		•	
Output current:	≤100 mA	•	•	•	•
Saturation voltage:	≤ 2 V	•	•	•	•
Response time:	1 ms	•	•	•	•
Switching frequency:	500 Hz	•	•	•	•
Operating mode:	light on NO / dark on NC	•	•	•	•
Connection:	2 m Ø 4 mm cable ⁴	•	•		
	M12 4-pole connector ⁵			•	•
Electrical protection:	class 2	•	•	•	•
Mechanical protection:	IP67	•	•	•	•
Protection devices:	A, B ⁶	•	•	•	•
Housing material:	ABS	•	•	•	•
Lens material:	window in PMMA ⁷	•	•	•	•
Weight:	90 g max.	•	•		
	40 g max.			•	•
Operating temperature:	-25 ... +55°C	•	•	•	•
Storage temperature:	-25 ... +70°C	•	•	•	•
Reference standard:	EN 60947-5-2	•	•	•	•

SELECTION TABLE

axial optics - 2 m cable		
S60-PA-2-C11-NN	956201480	NPN
S60-PA-2-C11-PP	956201320	PNP

axial optics -M12 connector		
S60-PA-5-C11-NN	956201200	NPN
S60-PA-5-C11-PP	956201110	PNP

All the ordering codes and information are summarised in the last pages of this catalogue.



DETECTION DIAGRAMS

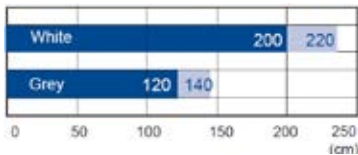

 Recommended operating distance
 Maximum operating distance

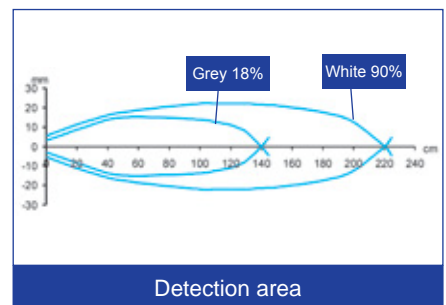
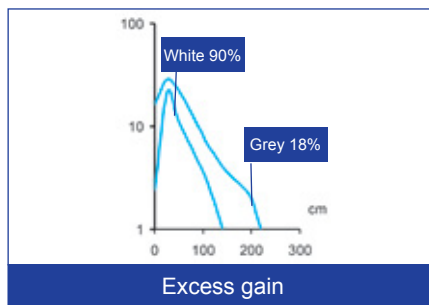

L-C RED EMISSION

The visible red laser emission allows the accurate detection of very small objects. The sensors operate as a proximity device up to 60 cm and can be used as a contrast sensor for high contrast mark detection. The class 1 laser emission, according to EN 60825-1, guarantees maximum safety for the operators in all applications.



DIMENSIONS

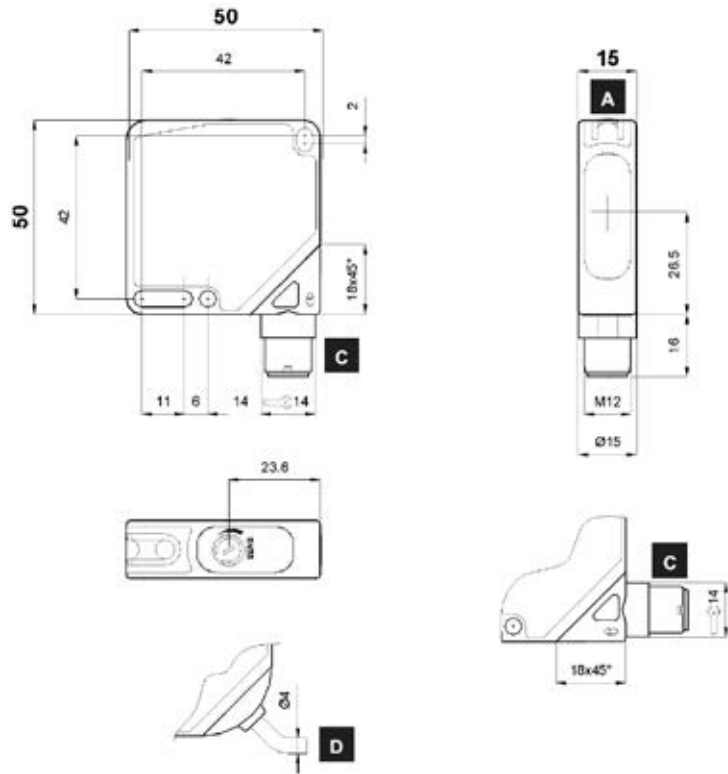

INDICATORS AND SETTINGS



- A** Output status and power on LEDs
- B** Adjustment trimmer
- C** M12 connector output
- D** Cable output

Single-turn trimmer for sensitivity adjustment. Rotate clockwise direction to increase the operating distance.

ACCESSORIES

For **dedicated accessories** refer to the **ACCESSORIES** section of this catalogue.

Refer also to **Connectors and Fixing brackets** of the **General Catalogue**.

CONNECTIONS



S60-PA-2

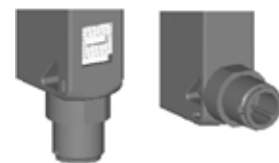

S60-PA-5

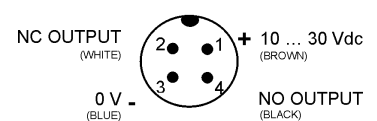
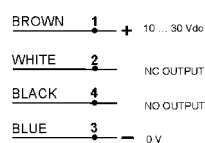

TECHNICAL DATA

TECHNICAL NOTES

- ¹Limit values
- ²Average life of 100.000 h with TA = +25 °C
- ³270° trimmer
- ⁴PVC, 4 x 0.14 mm²
- ⁵Connector can be blocked on two positions
- ⁶A - reverse polarity protection
B - overload and short-circuit protection on outputs
- ⁷Internal lenses in Polycarbonate

		S60-PL-2-C01-NN	S60-PL-2-C01-PP	S60-PL-5-C01-NN	S60-PL-5-C01-PP
Operating distance:	0 ... 60 cm	•	•	•	•
Power supply:	10 ... 30 Vdc ¹	•	•	•	•
Ripple:	≤ 2 Vpp	•	•	•	•
Consumption:	≤ 35 mA	•	•	•	•
Light emission:	red Laser 650 nm ²	•	•	•	•
	class 1 EN 60825-1	•	•	•	•
	class II CDRH21 CFR 1040.10	•	•	•	•
Resolution:	approx. 0.2 mm at 15 cm	•	•	•	•
	approx. 1 mm at 35 cm	•	•	•	•
	approx. 2 mm at 50 cm	•	•	•	•
Setting:	sensitivity trimmer ³	•	•	•	•
Indicators:	yellow OUTPUT LED	•	•	•	•
	green POWER ON LED	•	•	•	•
Output type:	PNP, NO and NC		•		•
	NPN, NO and NC	•		•	
Output current:	≤ 100 mA	•	•	•	•
Saturation voltage:	≤ 2 V	•	•	•	•
Response time:	250 μs	•	•	•	•
Switching frequency:	2 kHz	•	•	•	•
Operating mode:	light on NO / dark on NC	•	•	•	•
Connection:	2 m Ø 4 mm cable ⁴	•	•		
	M12 4-pole connector ⁵			•	•
Electrical protection:	class 2	•	•	•	•
Mechanical protection:	IP67	•	•	•	•
Protection devices:	A, B ⁶	•	•	•	•
Housing material:	ABS	•	•	•	•
Lens material:	window in PMMA ⁷	•	•	•	•
Weight:	90 g max.	•	•		
	40 g max.			•	•
Operating temperature:	-10 ... +50°C	•	•	•	•
Storage temperature:	-25 ... +70°C	•	•	•	•
Reference standard:	EN 60947-5-2, EN 60825-1, CDRH21 CFR 1040.10	•	•	•	•

SELECTION TABLE

axial optics - 2 m cable		
S60-PL-2-C01-NN	956201640	NPN
S60-PL-2-C01-PP	956201650	PNP

axial optics - M12 connector		
S60-PL-5-C01-NN	956201660	NPN
S60-PL-5-C01-PP	956201670	PNP

All the ordering codes and information are summarised in the last pages of this catalogue.



DETECTION DIAGRAMS

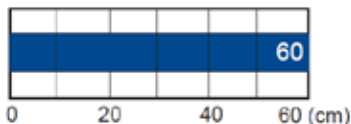

■ Operating distance

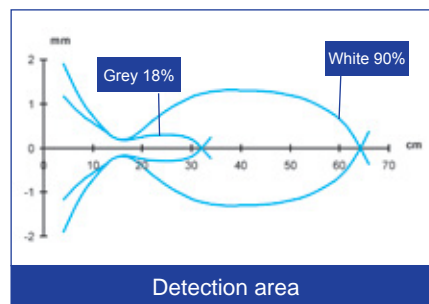

Detection area

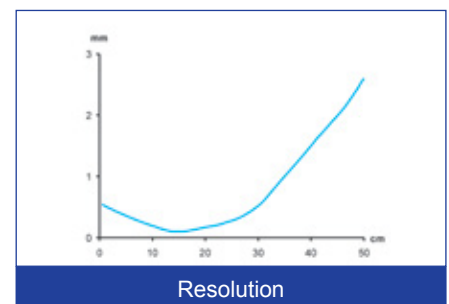

Resolution

M RED EMISSION

Background suppression proximity allows to precisely adjust the distance over which the object is not detected, with the minimum difference between different coloured objects. The EASYtouch™ setting procedure fixes automatically the best detection conditions with medium or high precision, simply pressing once the teach-in push-button, in presence of the background to suppress.



DIMENSIONS

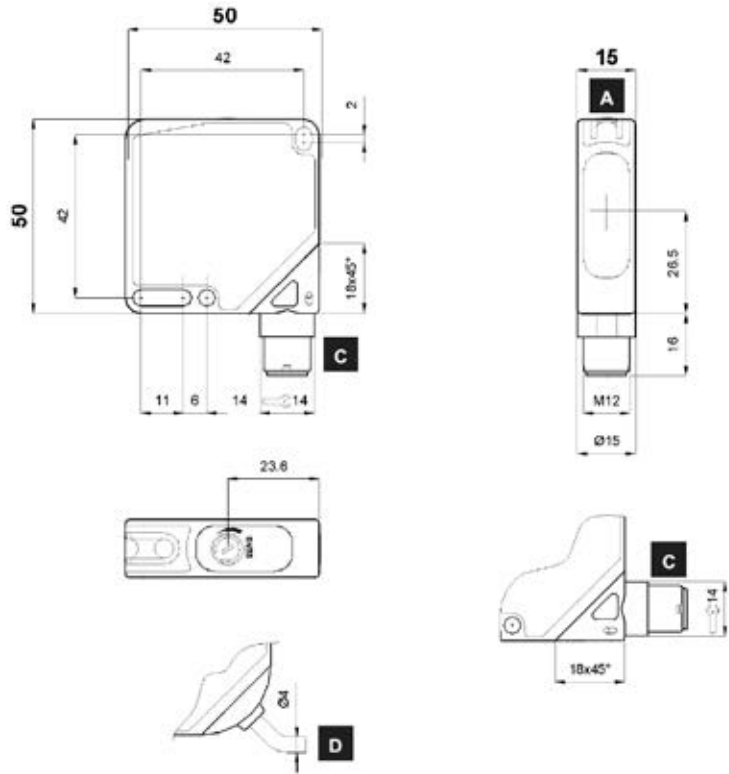

INDICATORS AND SETTINGS



- A** Output status and READY/ERROR LEDs
- B** Teach-in push-button
- C** M12 connector output
- D** Cable output

Teach-in button for setting.
EASYtouch™ provides two setting modes: standard or fine.
Please refer to instructions manual for operating details.

ACCESSORIES

For **dedicated accessories** refer to the **ACCESSORIES** section of this catalogue.

Refer also to **Connectors and Fixing brackets of the General Catalogue**.

CONNECTIONS

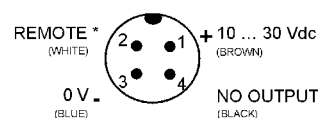
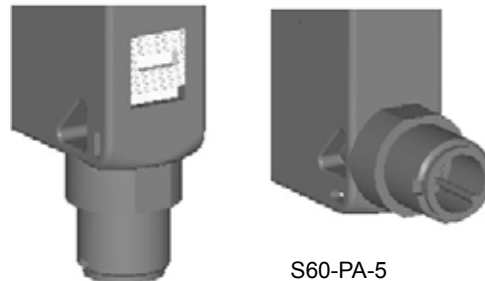

TECHNICAL DATA

TECHNICAL NOTES		S60-PA-5-M08-NH	S60-PA-5-M08-PH
¹ Limit values ² Average life of 100.000 h with TA = +25 °C ³ Connect to 0 V when remote wire not used ⁴ 270° trimmer ⁵ PVC, 4 x 0.14 mm ² ⁶ Connector can be blocked on two positions ⁷ A - reverse polarity protection B - overload and short-circuit protection on outputs ⁸ Internal lenses in Polycarbonate			
Operating distance:	7 ... 20 cm	•	•
Power supply:	10 ... 30 Vdc ¹	•	•
Ripple:	≤ 2 Vpp	•	•
Consumption:	≤ 30 mA	•	•
Light emission:	red LED 670 nm ²	•	•
Spot dimension:	approx. 16 mm at 20 cm	•	•
Setting:	teach-in push-button	•	•
	remote on cable ³	•	•
Setting procedure:	EASYtouch™	•	•
Indicators:	yellow OUTPUT LED	•	•
	green / red READY / ERROR LED	•	•
Output type:	PNP, NO		•
	NPN, NO	•	
Output current:	≤ 100 mA	•	•
Saturation voltage:	≤ 2 V	•	•
Response time:	500 μs	•	•
Max. switching frequency:	1 kHz	•	•
Operating mode:	light with EASYtouch™	•	•
	dark / light configurable	•	•
Timing function:	20 ms minimum output ON	•	•
Auxiliary functions:	remote	•	•
	keylock ⁴	•	•
Connection:	2 m Ø 4 mm cable ⁵		
	M12 4-pole connection ⁶	•	•
Electrical protection:	class 2	•	•
Mechanical protection:	IP67	•	•
Protection devices:	A, B ⁷	•	•
Housing material:	ABS	•	•
Lens material:	window in PMMA ⁸	•	•
Weight:	90 g max.		
	40 g max.	•	•
Operating temperature:	-25 ... +55 °C	•	•
Storage temperature:	-25 ... +70 °C	•	•
Reference standard:	EN 60947-5-2	•	•

SELECTION TABLE

axial optics - M12 connector		
S60-PA-5-M08-NH	956201220	NPN
S60-PA-5-M08-PH	956201080	PNP

All the ordering codes and information are summarised in the last pages of this catalogue.



DETECTION DIAGRAMS

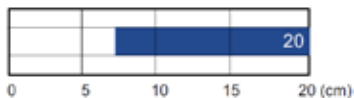

■ Operating distance



L-M RED EMISSION

The background suppression with red laser emission offers the best precision in terms of resolution and for background suppression, over which the object is not detected. The class 1 laser emission, according to EN 60825-1, guarantees maximum safety for the operators in all applications.



DIMENSIONS

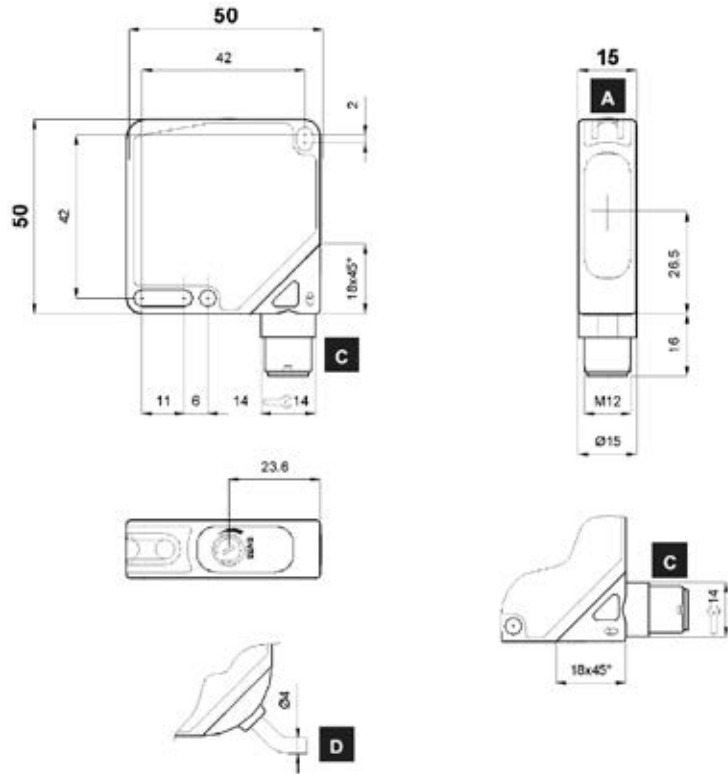

INDICATORS AND SETTINGS



- A** Output status and LASER ON S /ERROR LEDs
- B** Teach-in push-button
- C** M12 connector output
- D** Cable output

Teach-in button for setting. EASYtouch™ provides two setting modes: standard or fine. Please refer to instructions manual for operating details.

ACCESSORIES

For **dedicated accessories** refer to the **ACCESSORIES** section of this catalogue.

Refer also to **Connectors and Fixing brackets** of the **General Catalogue**.

CONNECTIONS



S60-PA-2

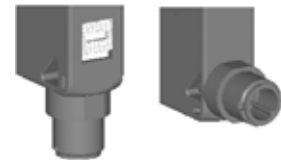

S60-PA-5

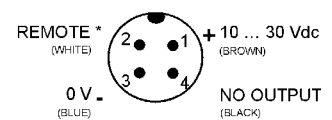
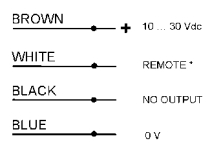

TECHNICAL DATA

TECHNICAL NOTES		S60-PL-2-M08-NN	S60-PL-2-M08-PP	S60-PL-5-M08-NN	S60-PL-5-M08-PP
¹ Limit values					
² Average life of 100.000 h with TA = +25 °C					
³ Connect to 0 V when remote wire not used					
⁴ 270° trimmer					
⁵ PVC, 4 x 0.14 mm ²					
⁶ Connector can be blocked on two positions					
⁷ A - reverse polarity protection					
⁸ B - overload and short-circuit protection on outputs					
⁹ Internal lenses in Polycarbonate					
Operating distance:	5 ... 10 cm	•	•	•	•
Power supply:	10 ... 30 Vdc ¹	•	•	•	•
Ripple:	≤ 2 Vpp	•	•	•	•
Consumption:	≤ 60 mA	•	•	•	•
Light emission:	red Laser 650 nm ²	•	•	•	•
	class 1 EN 60825-1	•	•	•	•
	class II CDRH21 CFR 1040.10	•	•	•	•
Resolution:	approx. 0.5 mm at 6 cm	•	•	•	•
Setting:	teach-in push-button	•	•	•	•
	remote on cable ³	•	•	•	•
Setting procedure:	EASYtouch™	•	•	•	•
Indicators:	yellow OUTPUT LED	•	•	•	•
	green / red LASER ON / ERROR LED	•	•	•	•
Output type:	PNP, NO	•	•	•	•
	NPN, NO	•	•	•	•
Output current:	≤ 100 mA	•	•	•	•
Saturation voltage:	≤ 2 V	•	•	•	•
Response time:	500 μs	•	•	•	•
Switching frequency:	1 kHz	•	•	•	•
Operating mode:	light with EASYtouch™	•	•	•	•
	dark / light configurable	•	•	•	•
Timing function:	20 ms minimum output ON	•	•	•	•
Auxiliary functions:	remote	•	•	•	•
	keylock ⁴	•	•	•	•
Connection:	2 m Ø 4 mm cable ⁵	•	•	•	•
	M12 4-pole connector ⁶	•	•	•	•
Electrical protection:	class 2	•	•	•	•
Mechanical protection:	IP67	•	•	•	•
Protection devices:	A, B ⁷	•	•	•	•
Housing material:	ABS	•	•	•	•
Lens material:	window in PMMA ⁸	•	•	•	•
Weight:	90 g max.	•	•	•	•
	40 g max.	•	•	•	•
Operating temperature:	-10 ... +50°C	•	•	•	•
Storage temperature:	-25 ... +70°C	•	•	•	•
Reference standard:	EN 60947-5-2,	•	•	•	•
	EN 60825-1, CDRH21 CFR 1040.10	•	•	•	•

SELECTION TABLE

axial optics - 2 m cable		
S60-PL-2-M08-NH	956201580	NPN
S60-PL-2-M08-PH	956201440	PNP

axial optics - M12 connector		
S60-PL-5-M08-NH	956201280	NPN
S60-PL-5-M08-PH	956201160	PNP

All the ordering codes and information are summarised in the last pages of this catalogue.



DETECTION DIAGRAMS

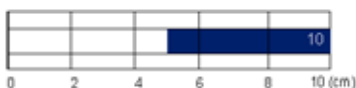

■ Operating distance

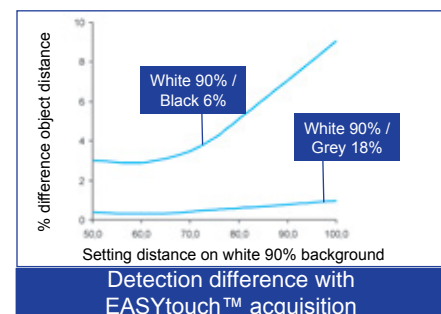

W RED EMISSION

The white light LED emission is designed for the detection of a large number of coloured or grey-scale contrasts, in order to detect print registration marks or similar. The patent-covered EASYtouch[®] setting procedures automatically selects the best detection conditions, simply by pressing the teach-in push-button once. A higher level of accuracy can be obtained or the dark/light operating mode can be inverted.



DIMENSIONS

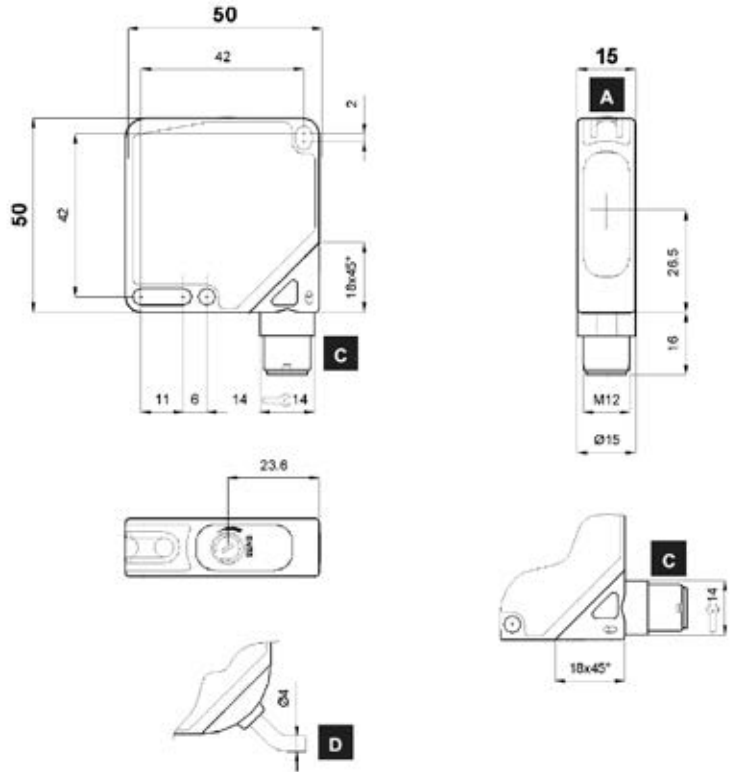

INDICATORS AND SETTINGS



- A** Output status and READY/ERROR LEDs
- B** Teach-in push-button
- C** M12 connector output orientable in two positions
- D** Cable output

Teach-in button for setting.
EASYtouch™ provides two setting modes: standard or fine.
Please refer to instructions manual for operating details.

ACCESSORIES

For **dedicated accessories** refer to the **ACCESSORIES** section of this catalogue.

Refer also to **Connectors and Fixing brackets** of the **General Catalogue**.

CONNECTIONS



S60-PA-2

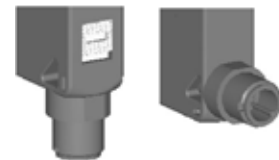

S60-PA-5

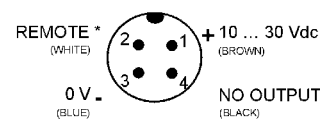
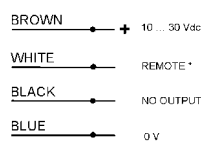

TECHNICAL DATA

TECHNICAL NOTES		S60-PA-5-W08-NH	S60-PA-5-W08-PH
¹ Limit values ² Average life of 100.000 h with TA = +25 °C ³ Connect to 0 V when remote wire not used ⁴ 270° trimmer ⁵ PVC, 4 x 0.14 mm ² ⁶ Connector can be blocked on two positions ⁷ A - reverse polarity protection B - overload and short-circuit protection on outputs ⁸ Internal lenses in glass			
Operating distance:	19 mm	•	•
Max. field of depth:	± 2 mm	•	•
Power supply:	10 ... 30 Vdc ¹	•	•
Ripple:	≤ 2 Vpp	•	•
Consumption:	≤30 mA	•	•
Light emission:	white LED 400 - 700 nm ²	•	•
Spot dimension:	aprox. 3.5 mm at 19 mm	•	•
Resolution:	0.5 mm	•	•
Setting:	teach-in push-button	•	•
	remote on cable ³	•	•
Setting procedure:	EASYtouch™	•	•
Indicators:	yellow OUTPUT LED	•	•
	green / red READY / ERROR LED	•	•
Output type:	PNP, NO	•	•
	NPN, NO	•	•
Output current:	≤ 100 mA	•	•
Saturation voltage:	≤ 2 V	•	•
Response time:	100 µs	•	•
Max. switching frequency:	5 kHz	•	•
Operating mode:	dark with EASYtouch™	•	•
	automatic dark / light with fine acquisition	•	•
Timing function:	20 ms minimum output ON	•	•
Auxiliary functions:	remote	•	•
	keylock ⁴	•	•
Connection:	2 m Ø 4 mm cable ⁵	•	•
	M12 4-pole connector ⁶	•	•
Electrical protection:	class 2	•	•
Mechanical protection:	IP67	•	•
Protection devices:	A, B ⁷	•	•
Housing material:	ABS	•	•
Lens materiale:	window in glass (tilted anti-reflection) ⁸	•	•
Weight:	90 g max.	•	•
	40 g max.	•	•
Operating temperature:	-25 ... +55°C	•	•
Storage temperature:	-25 ... +70°C	•	•
Reference standard:	EN 60947-5-2	•	•

SELECTION TABLE

contrast sensor - 2 m cable		
S60-PA-2-W08-NH	956201550	NPN
S60-PA-2-W08-PH	956201400	PNP

contrast sensor - M12 connector		
S60-PA-5-W08-NH	95621030	NPN
S60-PA-5-W08-PH	95621020	PNP

All the ordering codes and information are summarised in the last pages of this catalogue.



DETECTION DIAGRAMS

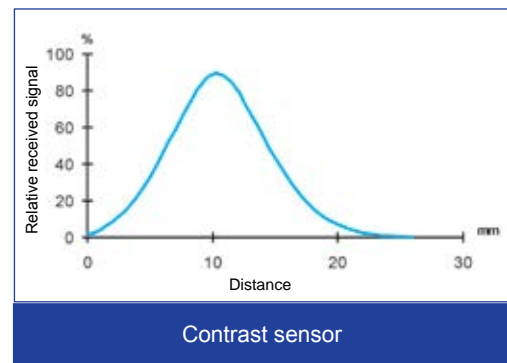
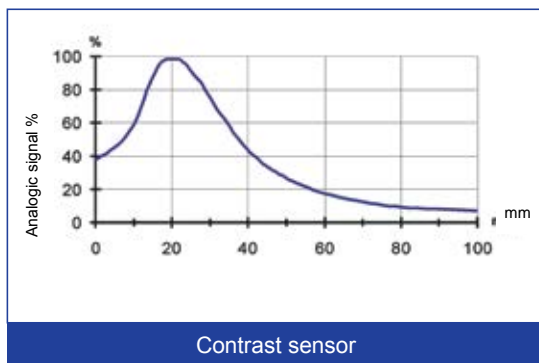

U UV EMISSION

The UV light LED emission detects any luminescent reference, even on very reflective surfaces, such as ceramics, metal or mirrored glass. The patent-covered EASYtouch™ setting procedures fixes automatically the best detection conditions, simply by pressing the teach-in push-button once, with the reference to detect. The threshold between two different luminescence degrees can be set by a second pressure of the button



DIMENSIONS

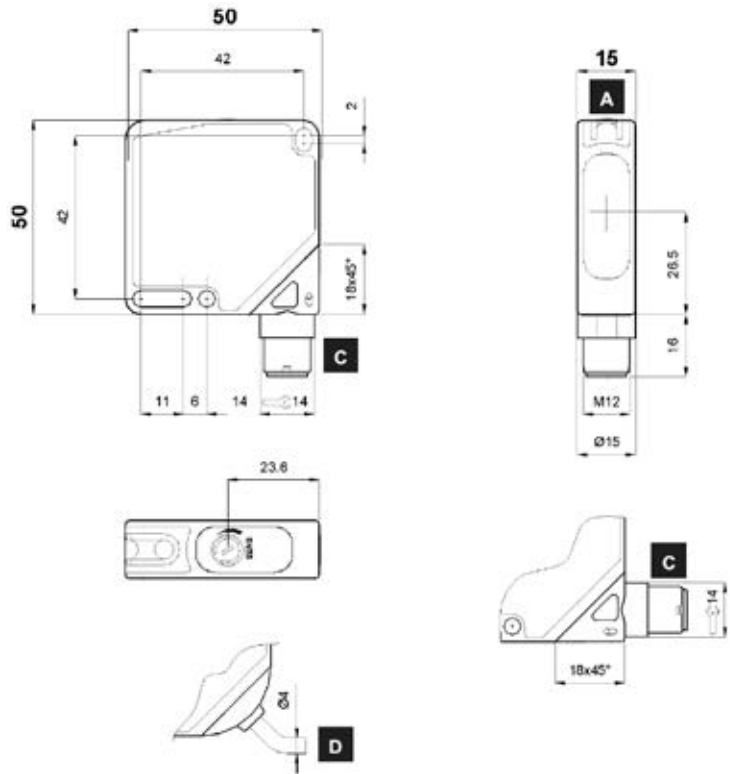

INDICATORS AND SETTINGS



- A** Output status and READY/ERROR LEDs
- B** Teach-in push-button
- C** M12 connector output orientable in two positions
- D** Cable output

Teach-in button for setting.
EASYtouch™ provides two setting modes: standard or fine.
Please refer to instructions manual for operating details.

ACCESSORIES

For **dedicated accessories** refer to the **ACCESSORIES** section of this catalogue.

Refer also to **Connectors and Fixing brackets** of the **General Catalogue**.

CONNECTIONS



S60-PA-2

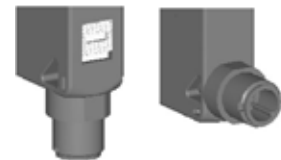

S60-PA-5

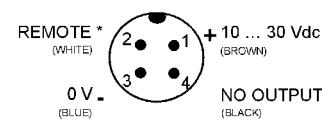
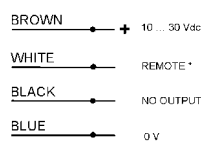

TECHNICAL DATA

TECHNICAL NOTES

- ¹Limit values
- ²Average life of 100.000 h with TA = +25 °C
- ³Connect to 0 V when remote wire not used
- ⁴270° trimmer
- ⁵PVC, 4 x 0.14 mm²
- ⁶Connector can be blocked on two positions
- ⁷A - reverse polarity protection
- ⁸B - overload and short-circuit protection on outputs
- ⁹Internal lenses in glass

		S60-PA-2-U08-NH	S60-PA-2-U08-PH	S60-PA-5-U08-NH	S60-PA-5-U08-PH
Operating distance:	0 ... 40 mm	•	•	•	•
Power supply :	10 ... 30 Vdc ¹	•	•	•	•
Ripple:	≤2 Vpp	•	•	•	•
Consumption:	≤ 30 mA	•	•	•	•
Light emission:	LED UV 370 nm ²	•	•	•	•
Spot dimension:	approx. 1.5 mm at 10 mm (max. signal)	•	•	•	•
Resolution:	0.5 mm	•	•	•	•
Setting:	teach-in push-button	•	•	•	•
	remote on cable ³	•	•	•	•
Setting procedure:	EASYtouch™	•	•	•	•
Indicators:	yellow OUTPUT LED	•	•	•	•
	green / red READY / ERROR LED	•	•	•	•
Output type:	PNP, NO	•	•	•	•
	NPN, NO	•	•	•	•
Output current:	≤ 100 mA	•	•	•	•
Saturation voltage:	≤ 2 V	•	•	•	•
Response time:	250 μs	•	•	•	•
Max. switching frequency:	2 kHz	•	•	•	•
Operating mode:	light with EASYtouch™	•	•	•	•
	automatic dark / light with fine acquisition	•	•	•	•
Timing function:	20 ms minimum output ON	•	•	•	•
Auxiliary functions:	remote	•	•	•	•
	keylock ⁴	•	•	•	•
Connection:	2 m Ø 4 mm cable ⁵	•	•	•	•
	M12 4-pole connector ⁶	•	•	•	•
Electrical protection:	class 2	•	•	•	•
Mechanical protection:	IP67	•	•	•	•
Protection devices:	A, B ⁷	•	•	•	•
Housing material:	ABS	•	•	•	•
Lens material:	window in glass (tilted anti-reflection) ⁸	•	•	•	•
Weight:	90 g max.	•	•	•	•
	40 g max.	•	•	•	•
Operating temperature:	-25 ... +55 °C	•	•	•	•
Storage temperature:	-25 ... +70 °C	•	•	•	•
Reference standard:	EN 60947-5-2	•	•	•	•

SELECTION TABLE

luminescence sensor - 2 m cable		
S60-PA-2-U08-NH	956201540	NPN
S60-PA-2-U08-PH	956201390	PNP

luminescence sensor - M12 connector		
S60-PA-5-U08-NH	956201010	NPN
S60-PA-5-U08-PH	956201000	PNP

All the ordering codes and information are summarised in the last pages of this catalogue.



DETECTION DIAGRAMS

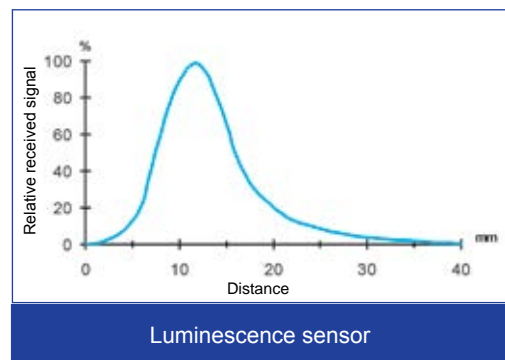
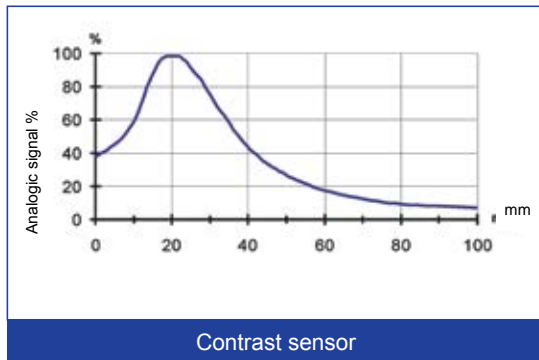

Y RED EMISSION

This sensor gives an analogue 0-10 Vdc output proportional to the target distance in the measurement range, with the possibility of setting a threshold for the other switching output. The yellow LED indicates the activation of the output during switching while the red LED turns on when the object is outside the measurement range.



DIMENSIONS

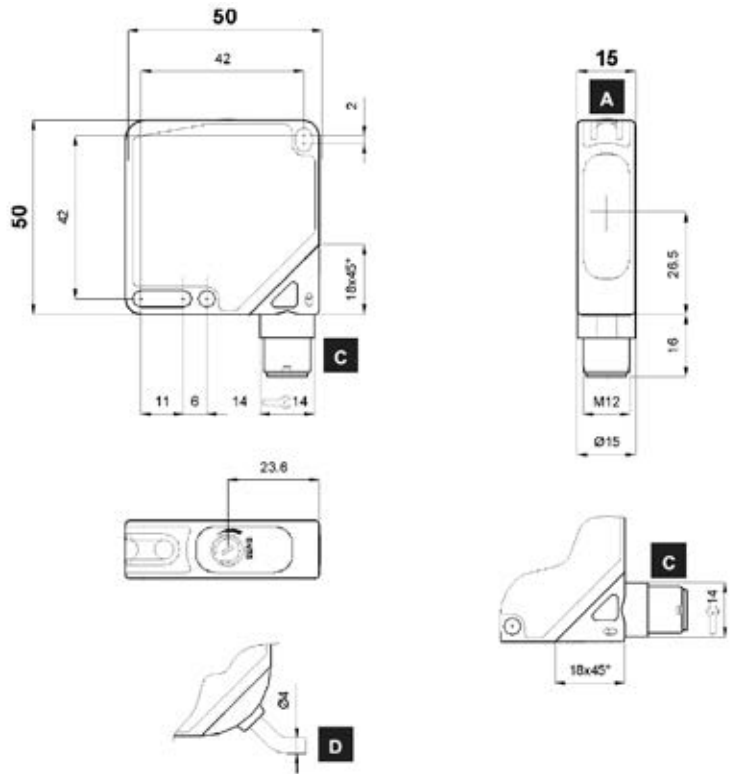

INDICATORS AND SETTINGS



- A** Output status and READY/ERROR LEDs
- B** Teach-in push-button
- C** M12 connector output orientable in two positions
- D** Cable output

Teach-in button for setting.
EASYtouch™ provides two setting modes: standard or fine.
Please refer to instructions manual for operating details.

ACCESSORIES

For **dedicated accessories** refer to the **ACCESSORIES** section of this catalogue.

Refer also to **Connectors and Fixing brackets** of the **General Catalogue**.

CONNECTIONS

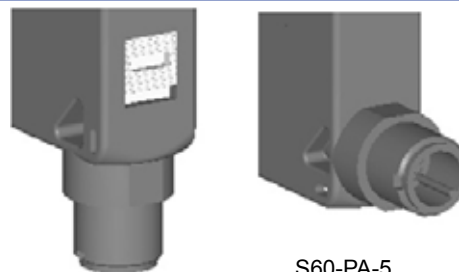

S60-PA-5

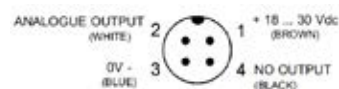

TECHNICAL DATA

TECHNICAL NOTES		S60-PA-5-Y03-NV	S60-PA-5-Y03-PV
¹ Measurement field can be reduced at device setting			
² Limit values			
³ Average life of 100.000 h with TA = +25 °C			
³ Connect to 0 V when remote wire not used			
⁴ PVC, 4 x 0.14 mm ²			
⁵ Connector can be blocked on two positions			
⁶ A - reverse polarity protection			
⁶ B - overload and short-circuit protection on outputs			
⁷ Internal lenses in Polycarbonate			
Operating distance:	60 ... 150 mm ¹	•	•
Power supply:	18 ... 30 Vdc ²	•	•
Ripple:	≤2 Vpp	•	•
Consumption:	≤60 mA	•	•
Light emission:	red LED 670 nm ³	•	•
Spot dimensions:	approx. 16 mm at 150 mm	•	•
Setting:	teach-in push-button	•	•
Setting procedure:	EASYtouch™	•	•
Indicators:	yellow OUTPUT LED	•	•
	red FIELD LED	•	•
Output type:	PNP, NO		•
	NPN, NO	•	
	analogue with 0 ... 10 V (8 bit)	•	•
Minimum resistance load:	1 KW	•	•
Output current:	≤100 mA	•	•
Saturage voltage:	≤ 2 V	•	•
Response time:	1 ms	•	•
Switching frequency:	500 Hz	•	•
Resolution:	1 mm (linearity ± 2.5 %)	•	•
Operating mode:	light with EASYtouch™	•	•
	automatic dark / light fine acquisition	•	•
	configurable direct/inverse proportionality	•	•
Switching output hysteresis:	10 % max.	•	•
Connection:	2 m Ø 4 mm cable ⁴		
	M12 4-pole connector ⁵	•	•
Electrical protection:	class 2	•	•
Mechanical protection:	IP67	•	•
Protection devices:	A, B ⁶	•	•
Housing material:	ABS	•	•
Lens material:	window in PMMA ⁷	•	•
Weight:	90 g max.		
	40 g max.	•	•
Operating temperature:	-25 ... +55°C	•	•
Storage temperature:	-25 ... +70°C	•	•
Reference standard:	EN 60947-5-2	•	•

SELECTION TABLE

distance sensor - M12 connector		
S60-PA-5-Y03-NV	956201710	PNP
S60-PA-5-Y03-PV	956201700	NPN

All the ordering codes and information are summarised in the last pages of this catalogue.



DETECTION DIAGRAMS

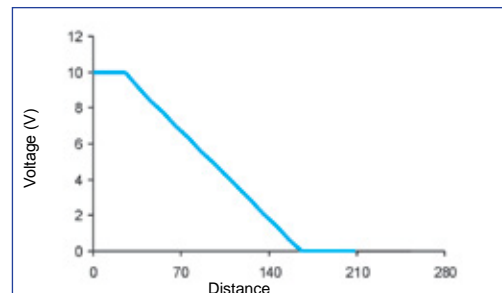
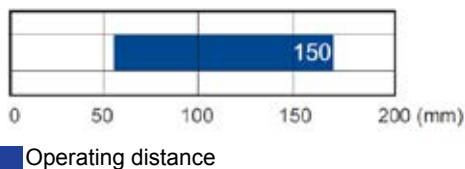

Analogue output on max. measurement range in inverse proportionality

TECHNOLOGY ADVANTAGES

The S60 series establishes the new market standard in the compact 50 x 50 mm photoelectric sensors, offering a complete family of optic functions with only 15 mm housing width.

The standard dimensions, reduced housing width and the multi-hole fixing system make the **S60** series compatible with the majority of compact sensors present on the market.

STANDARD 50 x 50 x 15 mm

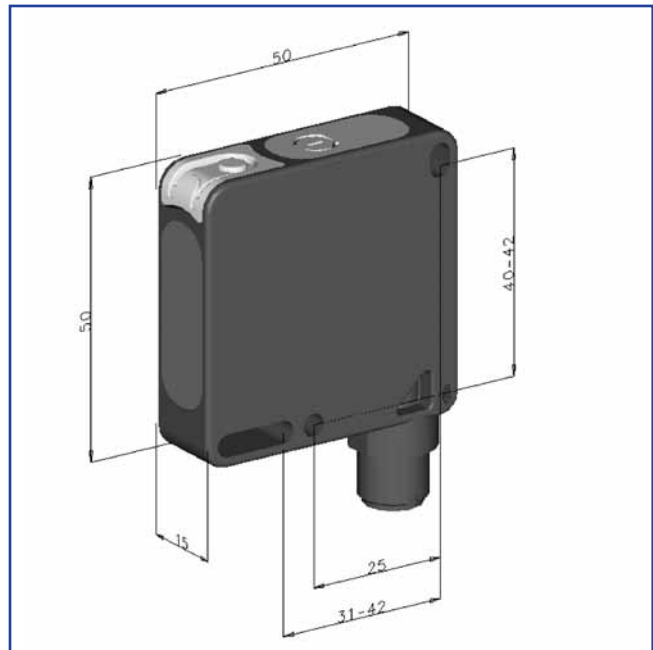
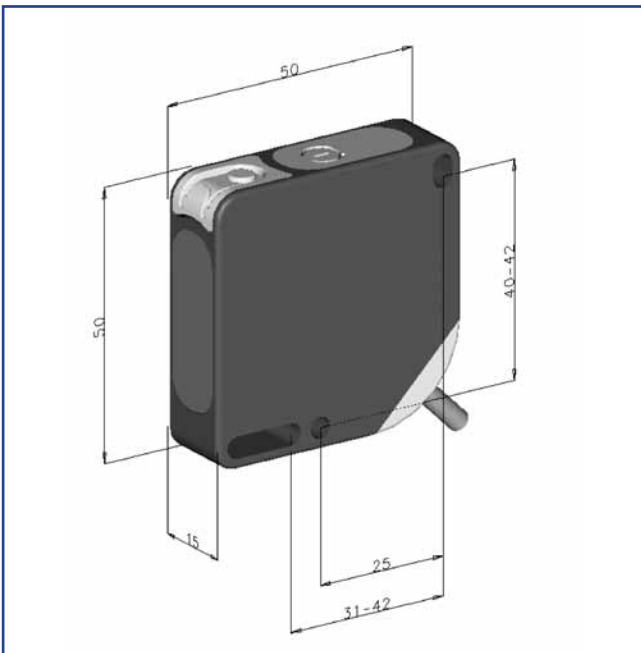

COMPACT PHOTOELECTRIC SENSORS

All the models are available in cable or M12 connector versions, with NPN or PNP type static output, conforming to the EN 60947-5-2 European standard.

The M12 connector can be easily rotated to 90° and can be blocked in the straight or right-angle positions respect to the optic axis, the cable emerges at 45° and thanks to its flexibility can rotate practically 360°. Thanks to these characteristics the sensor can be easily fixed on all sides and at all angles.

All the basic optic functions such as the through beam, polarised retroreflex, diffuse proximity and background suppression are available also in the version with visible red laser emission, with all the safety characteristics for the user in class 1 conforming to the EN 60825-1 European standard and in class II according to CDRH21 CFR Part 1040 USA standard.

Besides the evident advantages for the alignment of sensors and of the object to detect, thanks to the high spot visibility and concentration, the laser emissions offer an improved detection resolution, millimetric for the through beam and polarised retroreflex versions, or decimillimetric for the diffuse proximity and background suppression.

The polarised retroreflex model is available also in the coaxial optic version that, with the emitter optic axis coinciding with the receiver one, offers a better detection axis precision and the elimination of the blind zone near to the sensor.

TECHNOLOGY ADVANTAGES

The coaxial optics is present also in the polarised retroreflex model for the detection of transparent objects, notably increasing the performances of this optic function and its immunity to object movements inside the detection area.

The contrast sensor with white LED emission has an operating distance ranging from 17 to 21 mm and detects coloured or grey-scale marks, with a minimum dimension of 0.5 mm and an operating frequency reaching 5 kHz.

The luminescence sensor with UV LED emission has an operating distance ranging from 0 to 40 mm and detects fluorescent or luminescent targets, with a minimum dimension of 0.5 mm and an operating frequency reaching 2 kHz.

The setting of these sensors is extremely rapid and easy, thanks to the patent-covered **EASYtouch™** system that allows to automatically fix the object detection threshold, with a single pressure of the teach-in push-button.

It is possible to set the sensor to detect more critical differences between the mark and the background, or invert the dark or light operating mode, by pressing twice the push-button.

The EASYtouch™ system allows to select the 'Remote' function for the remote sensor setting through the cable or connector, the 'Keylock' function to block the keyboard, 'Delay OFF' function for the 20 ms timing of the output deactivation.

The sensor technology with background and/or foreground suppression of the **S60** series has allowed to develop also a cost-effective distance sensor with a double output: a 0 - 10 V analogue output and a digital NPN or PNP switching output.

The measurement range and the switching threshold output can be selected in the 50 - 150 mm range, with a ± 1 mm precision; the direct or inverse proportionality and the light or dark operating mode can be selected.

SMT chip-size for the electronic miniaturisation and more space for the optics

COAXIAL OPTICS

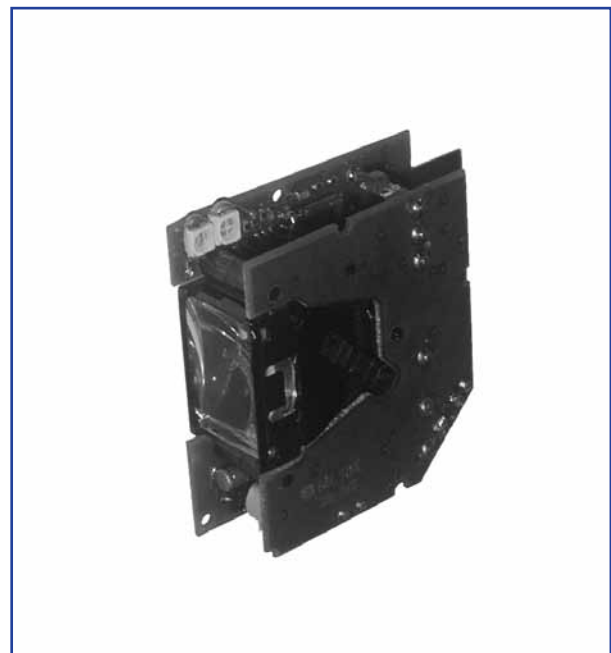
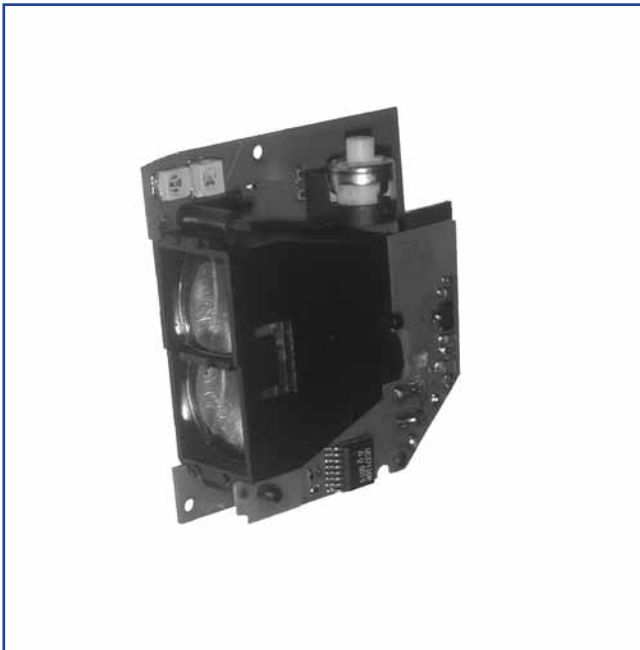

BIAXIAL OPTICS

Complete external shield for high electromagnetic compatibility

DIMENSIONS

ACCESSORIES

JOINT-60

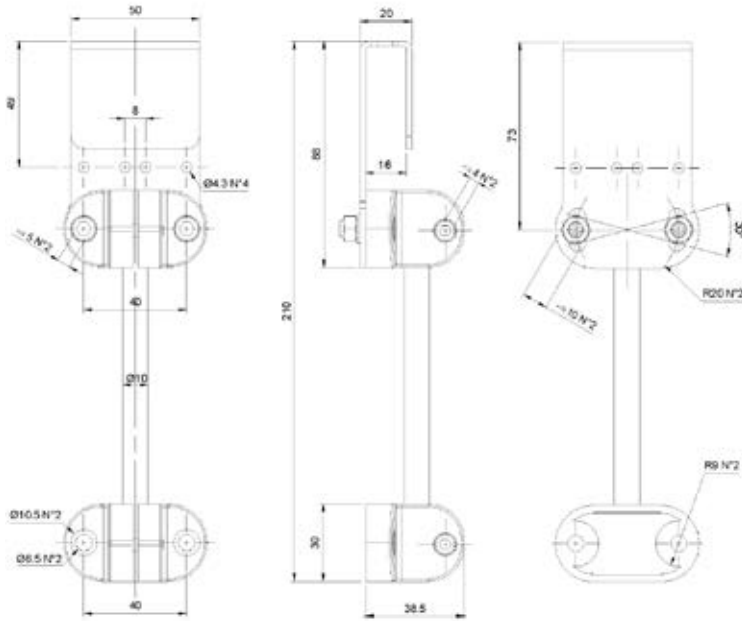

ST-504

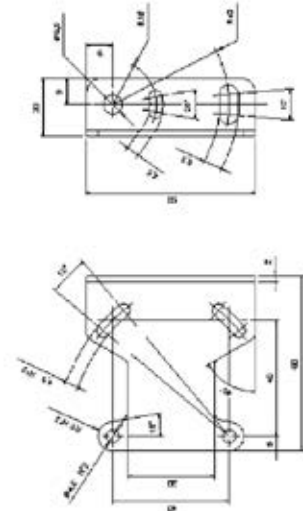

ST-5018

ST-5019

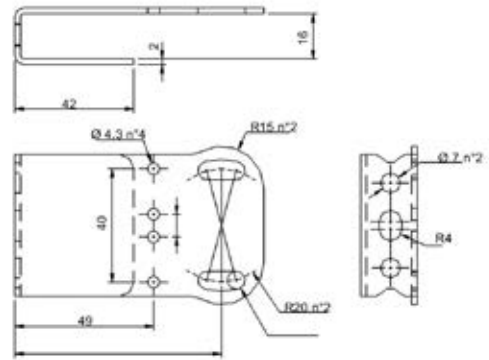
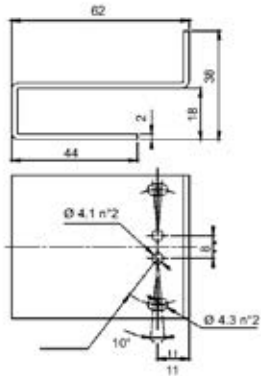

ST-5020

ST-5021

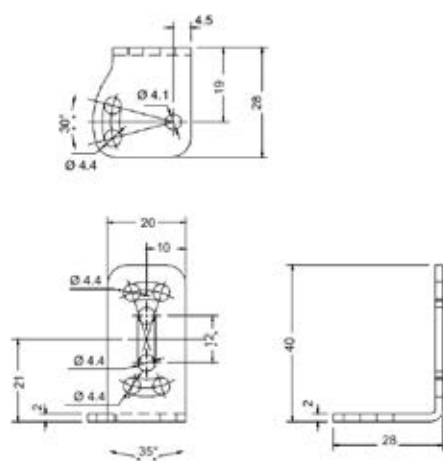
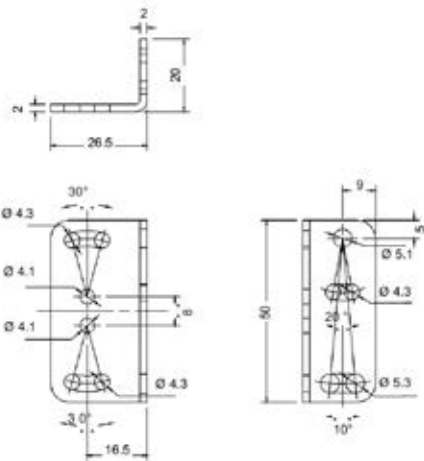

ACCESSORIES

The series is compatible with the following Datalogic Automation accessories (refer **General Catalogue**)

- CS connectors
- R reflectors

New accessories dedicated to the **S60** series have been developed to cover all the fixing requirements and improve functioning.

ACCESSORY SELECTION AND ORDER INFORMATION

MODEL	DESCRIPTION	ORDER N°
ST-5018	protection bracket	95ACC5310
ST-5019	protection bracket	95ACC5320
ST-5020	fixing bracket	95ACC5330
ST-5021	fixing bracket	95ACC5340
JOINT-60	protection bracket with jointed support	95ACC5350
ST-504	S6/S60 fixing bracket	95ACC2820

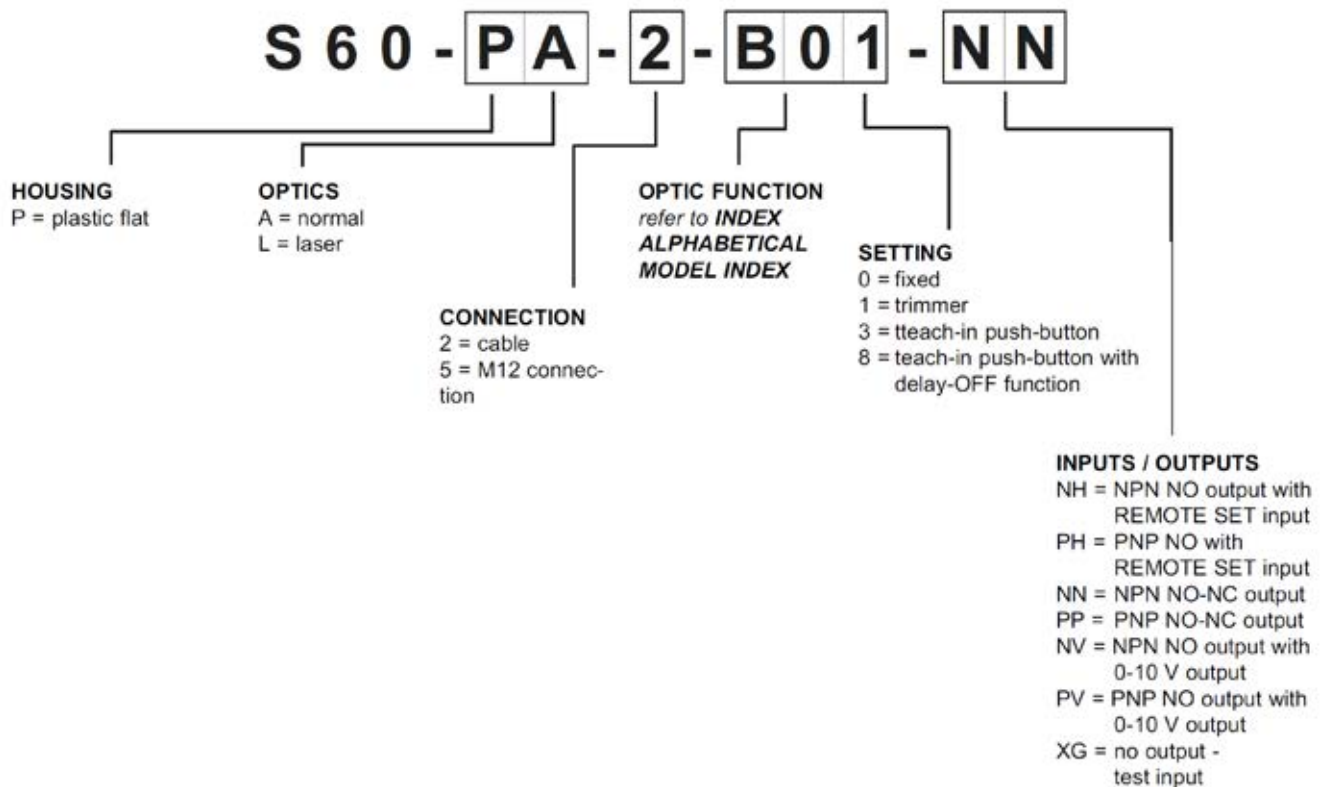

Note: Not all code combinations are available. Please refer to alphabetical model index for the list of available models.

MODEL SELECTION AND ORDER INFORMATION

MODEL	FUNCTION	N° ORDER	PAGE
S60-PA-2-B01-NN	polarised retroreflex	956201460	6
S60-PA-2-B01-PP	polarised retroreflex	956201300	6
S60-PA-2-C01-NN	diffuse proximity	956201470	14
S60-PA-2-C01-PP	diffuse proximity	956201310	14
S60-PA-2-C11-NN	long diffuse proximity	956201480	16
S60-PA-2-C11-PP	long diffuse proximity	956201320	16
S60-PA-2-F01-NN	recevier	956201490	2
S60-PA-2-F01-PP	recevier	956201330	2
S60-PA-2-G00-XG	emitter	956201340	2
S60-PA-2-T51-NN	retroreflex for transparents	956201530	12
S60-PA-2-T51-PP	retroreflex for transparents	956201380	12
S60-PA-2-U08-NH	luminescence sensor	956201540	28
S60-PA-2-U08-PH	luminescence sensor	956201390	28
S60-PA-2-W08-NH	contrast sensor	956201550	26
S60-PA-2-W08-PH	contrast sensor	956201400	26
S60-PA-5-B01-NN	polarised retroreflex	956201180	6
S60-PA-5-B01-PP	polarised retroreflex	956201040	6
S60-PA-5-B51-NN	coaxial polarised retroreflex	956201630	8
S60-PA-5-B51-PP	coaxial polarised retroreflex	956201620	8
S60-PA-5-C01-NN	diffuse proximity	956201190	14
S60-PA-5-C01-PP	diffuse proximity	956201050	14
S60-PA-5-C11-NN	long diffuse proximity	956201200	16
S60-PA-5-C11-PP	long diffuse proximity	956201110	16
S60-PA-5-F01-NN	recevier	956201210	2
S50-PA-5-F01-PP	recevier	956201060	2
S60-PA-5-G00-XG	emitter	956201070	2
S60-PA-5-M08-NH	background suppression	956201220	20
S60-PA-5-M08-PH	background suppression	956201080	20

MODEL	FUNCTION	N° ORDER	PAGE
S60-PA-5-N03-NH	fore-background suppression	956201240	24
S60-PA-5-N03-PH	fore-background suppression	956201090	24
S60-PA-5-T51-NN	retroreflex for transparents	956201250	12
S60-PA-5-T51-PP	retroreflex for transparents	956201100	12
S60-PA-5-U08-NH	luminescence sensor	956201010	28
S60-PA-5-U08-PH	luminescence sensor	956201000	28
S60-PA-5-W08-NH	contrast sensor	956201030	26
S60-PA-5-W08-PH	contrast sensor	956201020	26
S60-PA-5-Y03-NV	distance sensor	956201700	30
S60-PA-5-Y03-PV	distance sensor	956201710	30
S60-PL-2-B01-NN	laser polarised retroreflex	956201560	10
S60-PL-2-B01-PP	laser polarised retroreflex	956201410	10
S60-PL-2-C01-NN	laser diffuse proximity	956201640	18
S60-PL-2-C01-PP	laser diffuse proximity	956201650	18
S60-PL-2-F01-NN	laser receiver	956201570	4
S60-PL-2-F01-PP	laser receiver	956201420	4
S60-PL-2-G00-XG	laser emitter	956201430	4
S60-PL-2-M08-NH	laser background suppression	956201580	22
S60-PL-2-M08-PH	laser background suppression	956201440	22
S60-PL-5-B01-NN	laser polarised retroreflex	956201260	10
S60-PL-5-B01-PP	laser polarised retroreflex	956201120	10
S60-PL-5-C01-NN	laser diffuse proximity	956201660	18
S60-PL-5-C01-PP	laser diffuse proximity	956201670	18
S60-PL-5-F01-NN	laser receiver	956201270	4
S50-PL-5-F01-PP	laser receiver	956201140	4
S60-PL-5-G00-XG	laser emitter	956201150	4
S60-PL-5-M08-NH	laser background suppression	956201280	22
S60-PL-5-M08-PH	laser background suppression	956201160	22



The company endeavours to continuously improve and renew its products; for this reason the technical data and contents of this catalogue may undergo variations without prior notice. For correct installation and use, the company can guarantee only the data indicated in the instruction manual supplied with the products.